

# ALEFA

## TECHNICAL HANDBOOK





**2980**  
**OPTIONS**

**DESIGNED**  
**BY YOU**

# saloni

art of furniture

## WHY SALONI?



"Alfa dressing rooms" were introduced to the market with a leading design approach, resulting from a year-long, innovation-filled effort. Incorporating dozens of innovations, it has taken its place at the forefront of bedroom furniture manufacturers.

We recognize that our customers are very special individuals who know their own needs and make their own decisions about their choices. They do not want to have products in their lives that they cannot change or choose, especially a bedroom, which is a very private space.



**Sadi YILDIZ**  
General  
Manager

ALFA means wardrobe.  
ALFA means ability to choose from 2980  
different wardrobes.

It means being able to freely decide on its  
color, door, height, and interior modules.  
ALFA is a collection that turns the dreams  
of Saloni customers into reality.

With the ALFA wardrobe that you design and purchase, you can move your dressing room to your new home just like a regular bedroom. You will not need to have another dressing room made with its industrial manufacturing and connection methods. If you want to add new modules, even years later, you can still purchase the same color, quality, and design. You can move the extra modules to other suitable parts of your home. Your needs may change as you live and develop. ALFA offers you the opportunity to change the interior and add new modules even after years. We assure you that we have a wardrobe that you will definitely like.



# TABLE OF CONTENTS



- 8 **WHY SHALL I GO FOR ALFA?**
- 10 **START DESIGNING YOUR DRESSING ROOM**
- 14 **DETERMINE THE HEIGHT**
- 16 **DETERMINE THE MAIN CABINETS**
- 20 **CHOOSE THE CABINET INTERIOR MODULES**
- 24 **DESIGN YOUR OWN WARDROBE**
- 54 **CHOOSE YOUR COLOR**
- 56 **SELECT THE CABINET DOORS**
- 62 **SELECT EXTRA MODULES**

# 01

## WHY SHALL I GO FOR ALFA?

Alfa is a dressing room with portability feature.

With the solutions provided by ALFA, you can have fully-sized Cabinets for your bedroom and dressing room. Due to its industrial design, it can be easily dismantled and reassembled when moving to a new home. If your new home is larger, you can buy the same color and model Cabinets years later and recreate your perfect room without any missing spaces.



# 02

## START DESIGNING YOUR DRESSING ROOM

Alfa can fill your dressing room up to the last centimeter. You can share your room's dimensions with us by measuring it yourself or you can request help from our store to determine the measurements of your room.

As you will see in a few steps, you should first decide on the main shape of your wardrobe. You can design your room without restrictions by choosing a wardrobe that is shaped either "U", "L" or a combination of both.



You can determine the height, width, and all other details of your wardrobe according to the size of your room and your needs.

**Sliding door cabinets: two meters high**

**Hinged cabinets (Double and single) : 1 meters and half a meter**

**Corner cabinets: 95 cm**

With the information provided above, you can easily and practically calculate how many of each type of cabinet you will need in your room.

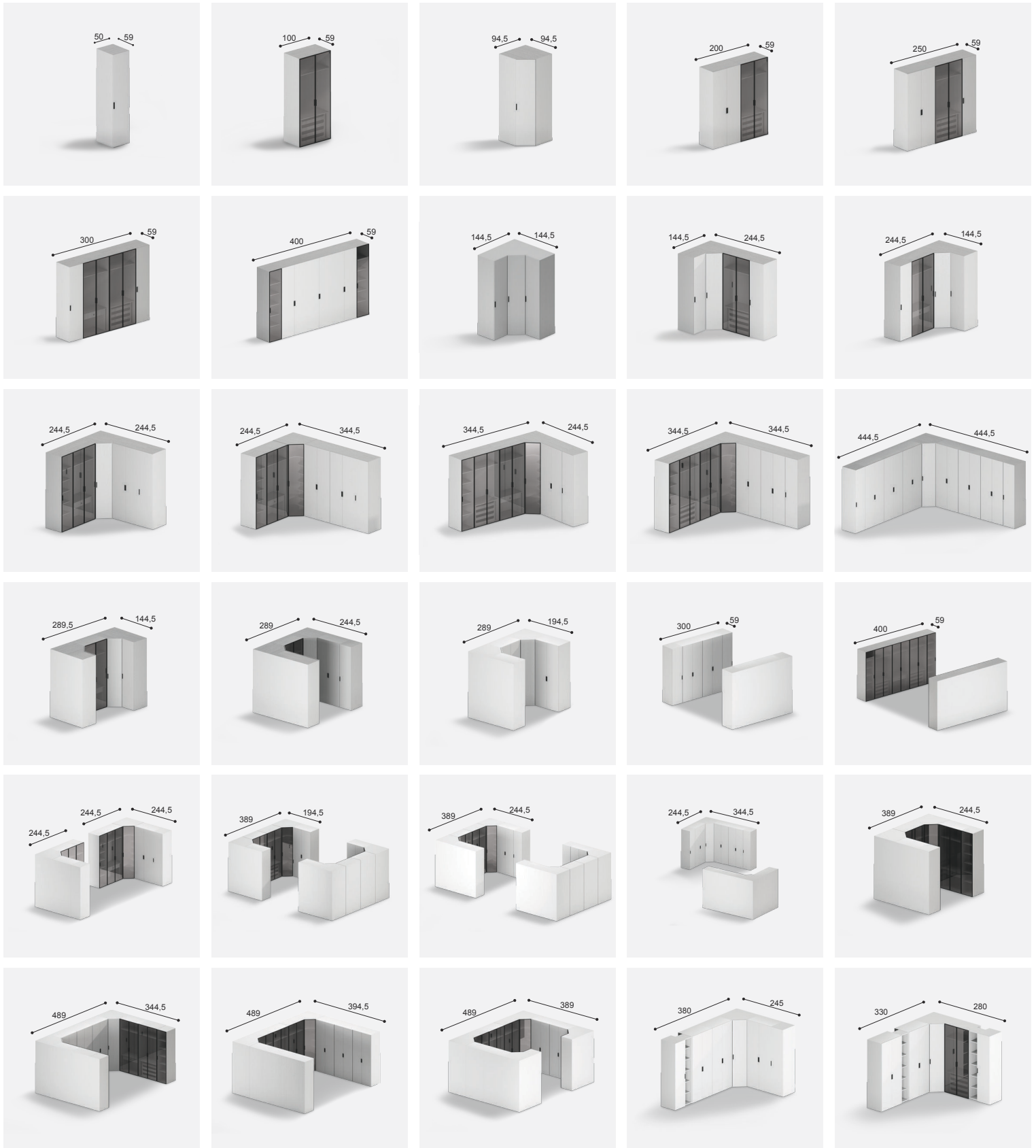

# 03

## CHOOSE YOUR HEIGHT

### SELECT FROM 4 DIFFERENT HEIGHTS

If you are looking for a wardrobe that suits your needs, ALFA's height options allow you to personalize your wardrobe and design it exactly the way you want it by choosing the one that suits you best. For example, if you have a room with high ceilings, you can create a wider space with the 260 cm height option, while the 210 cm height option will make your wardrobe look like it was specially designed for the dimensions of your smaller room.

**If you choose the height of your wardrobe according to the ceiling height:**

- ° You will have more storage space.
- ° There will be no unnecessary space on top of the wardrobe.
- ° Remember! If there is an opening of less than 10 centimeters between your ceiling and wardrobe height, your wardrobe will never topple over in the event of an earthquake and will not pose a danger to you.

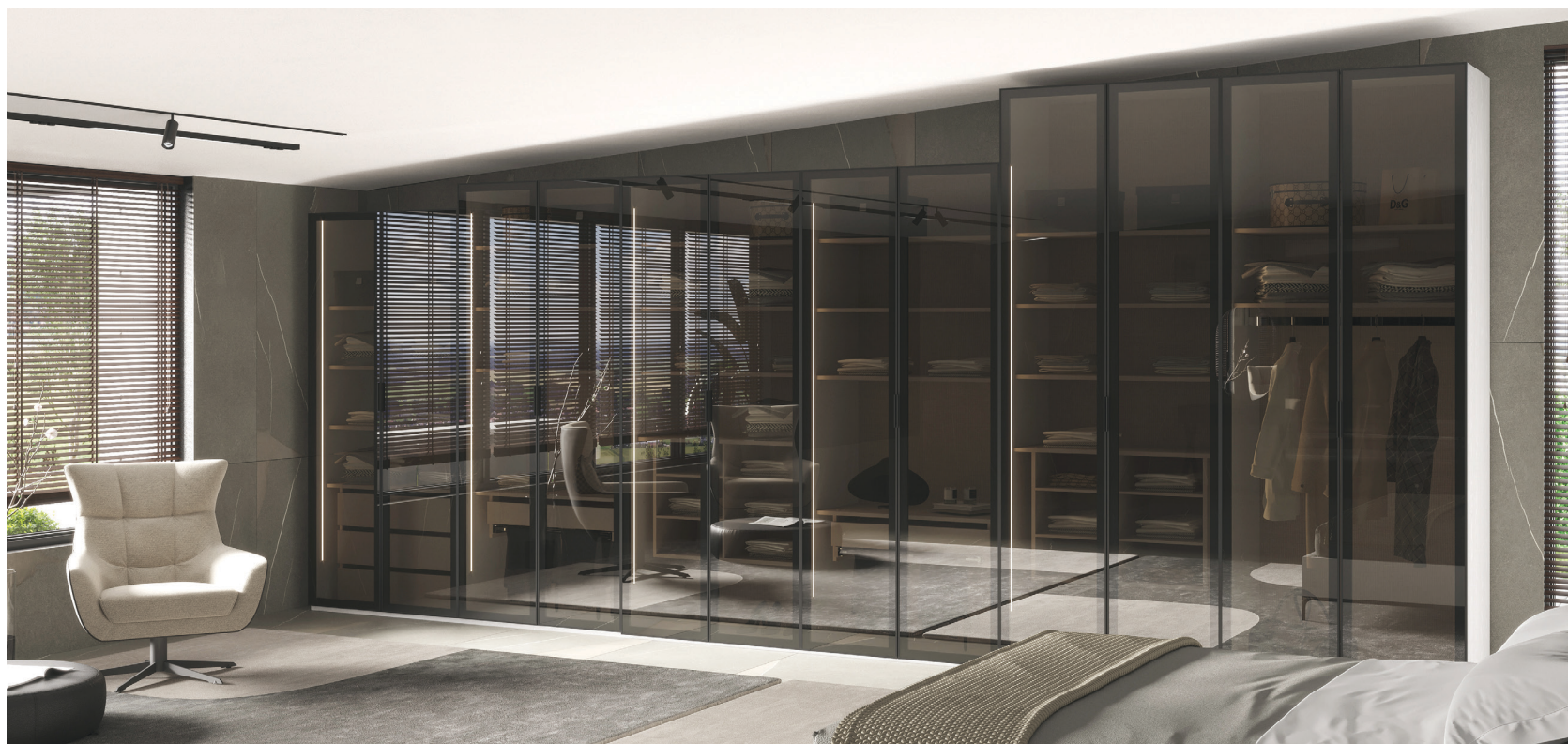



For hinged Cabinets (Double and Single), there should be a minimum gap of 4 cm between the ceiling and the top of the wardrobe.



For sliding Cabinets, there should be a minimum gap of 10 cm between the ceiling and the top of the wardrobe.

260<sub>cm</sub>

245<sub>cm</sub>

228<sub>cm</sub>

210<sub>cm</sub>

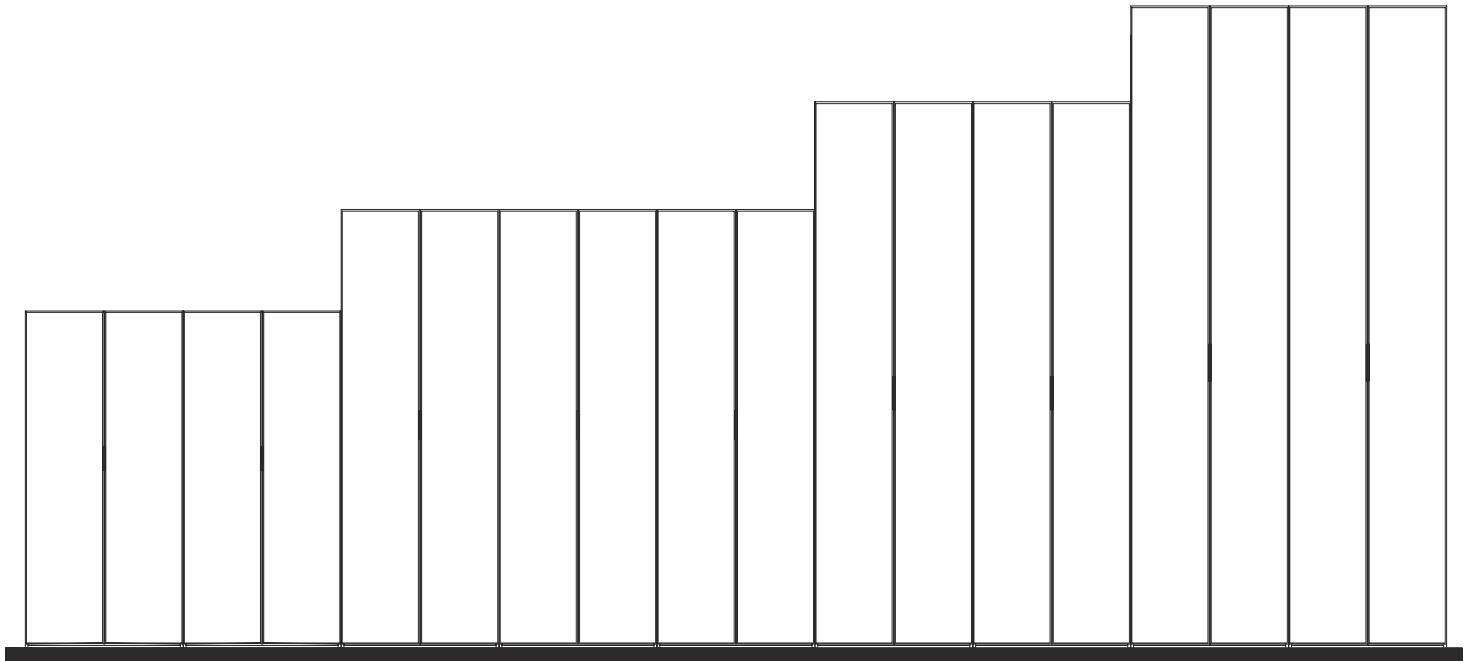
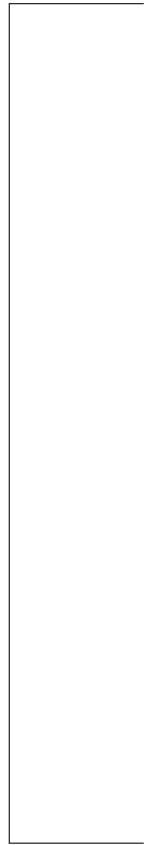

# 04

## DETERMINE YOUR MAIN CABINETS

Determining your main cabinets makes your dressing room functional

First, determine the main cabinets by Categorizing your clothes, shoes or any other accessories that take the most place in your dressing room or wardrobe and according to that chose the right cabinets to make your space more functional and practical.

**G 01 / ALFA / SINGLE CABINET:** A hinged, 50 cm wide cabinet with four different height options. It can accommodate seven types of doors, which can be installed on either the right or left side. The back panels are 8 mm thick, and the hinges open up to 105 degrees.

**G 02 / ALFA / DOUBLE CABINET:** A hinged, 100 cm wide cabinet with four different height options. It can accommodate seven types of doors. The back panels are 8 mm thick, and the hinges open up to 105 degrees.

**G 03 / ALFA / SLIDING DOOR CABINET:** A 200 cm wide wardrobe with sliding doors, available in four different height options. It can

accommodate four types of doors, and the back panels are 8 mm thick. The doors are equipped with a soft-closing system.

**D 09 / ALFA / CORNER CABINET:** A hinged, 95×95 cm wide cabinet with four different height options. It can accommodate seven types of doors, which can only be opened to the right side. The hinges open up to 165 degrees.

**D 10 / ALFA / MIDDLE CABINET:** Available in width options of 20, 25, 30, 35, 40, and 45 cm, this open cabinet does not come with doors. It is available in six different colors and four different height options, with a depth of 40 cm.

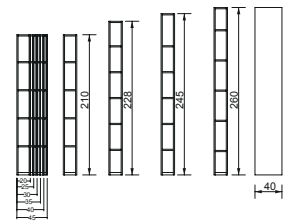
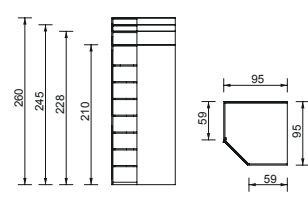
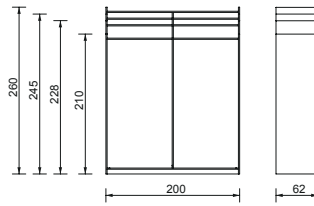
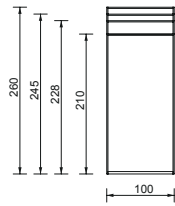
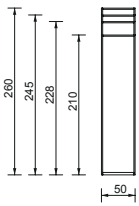
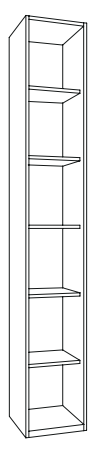
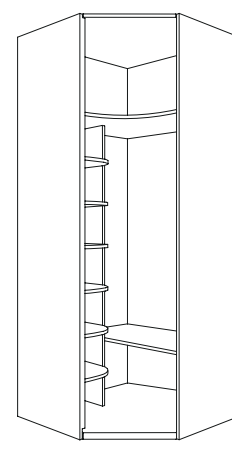
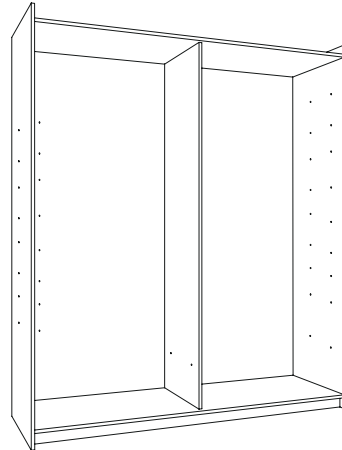
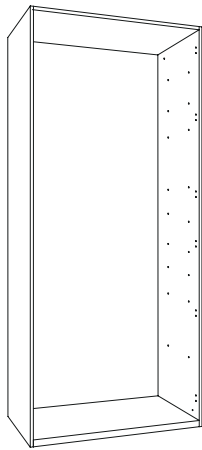
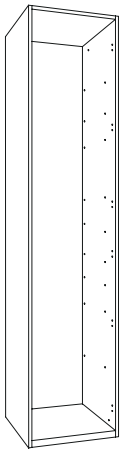

**G 01**

**ALFA**  
SINGLE  
CABINET

**G 02**

**ALFA**  
DOUBLE  
CABINET

**G 03**

**ALFA**  
CABINET  
WITH SLIDING  
DOORS

**D 09**

**ALFA**  
CORNER  
CABINET

**D 10**

**ALFA**  
MIDDLE  
CABINET

# COMPLETE YOUR WALL WITH MIDDLE CABINET

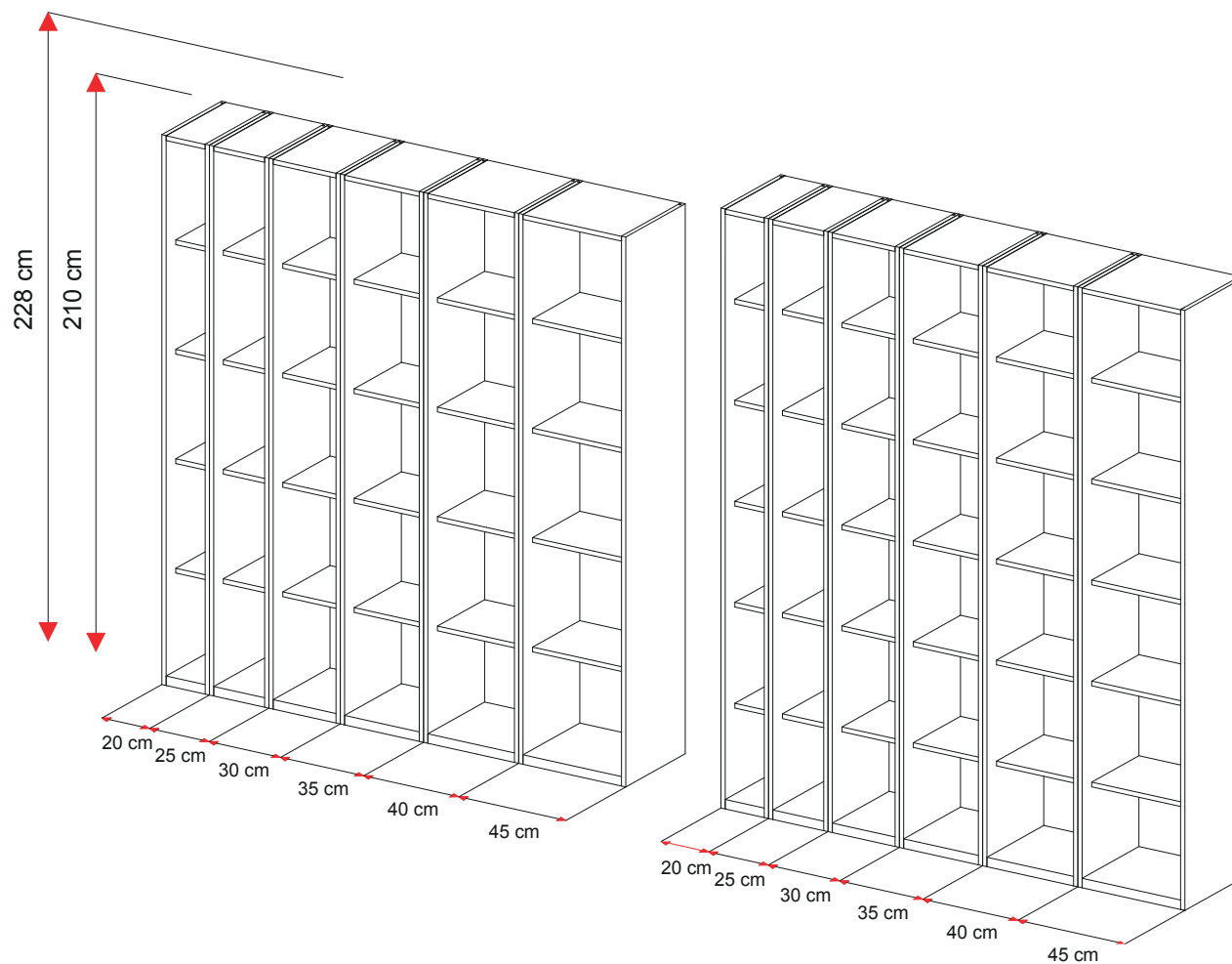

When building cabinets from wall to wall, standard cabinets may leave gaps that cannot be filled.

In such cases, our alfa middle cabinet module comes into play and provides you with the most suitable middle cabinets for the remaining space.

Alfa middle cabinet prevents awkward and empty spaces in your rooms with its six different width measurements.

You can choose from 120 different middle cabinet modules to fit your needs.

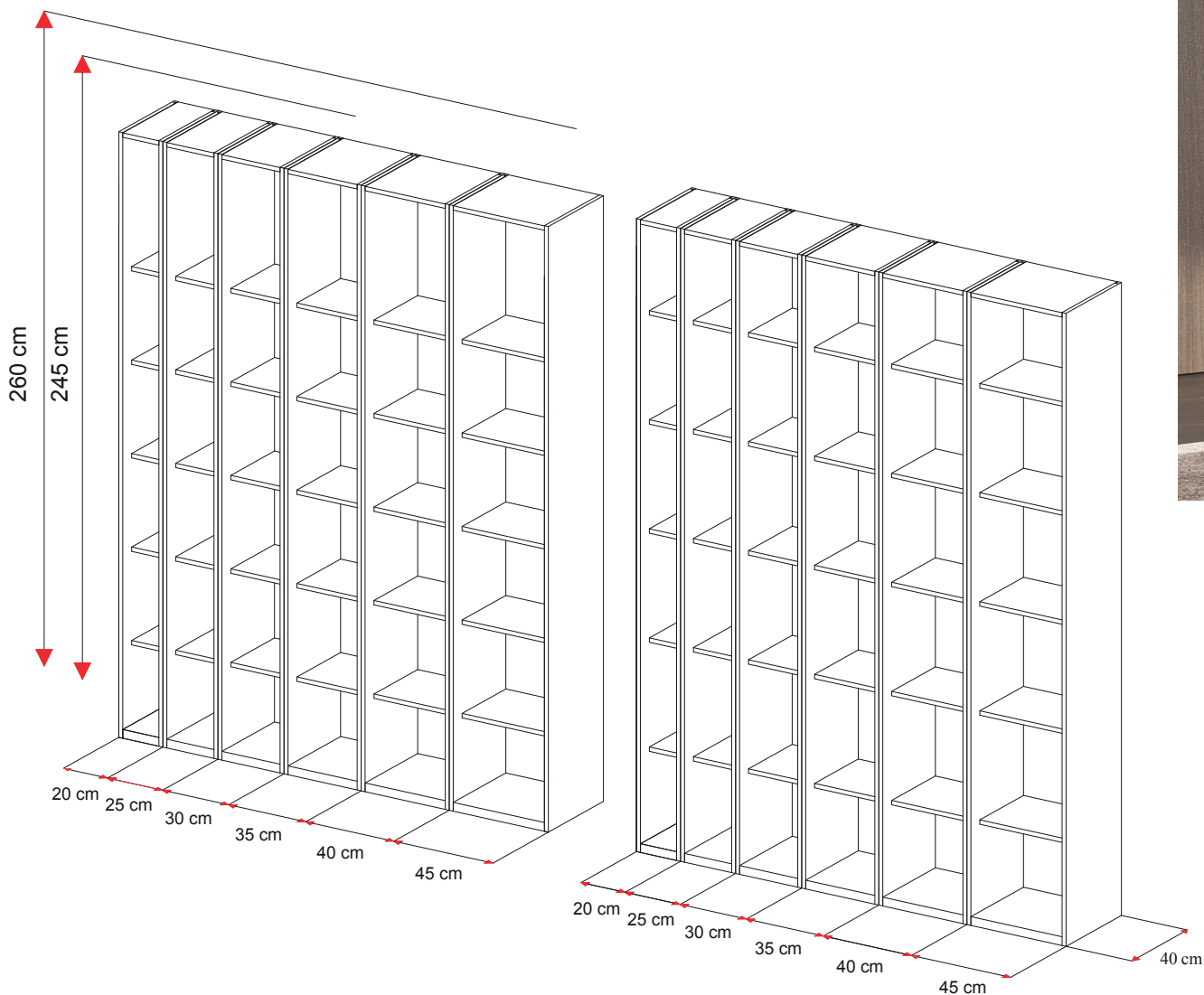

# 05

## SELECT YOUR CABINET MODULES

THE STORY OF ALFA CABINET SYSTEMS BEGAN WITH THE IDEA "DESIGN YOUR OWN WARDROBE".

You can select and place one of our 20 types of interior modules into the pre-drilled holes on the sides of the cabinet according to a certain plan. Every detail you need in your dressing room can be fulfilled by these modules that respond to your needs. ALFA inside modules also offer features such as replacement and expansion to meet your changing needs over time.

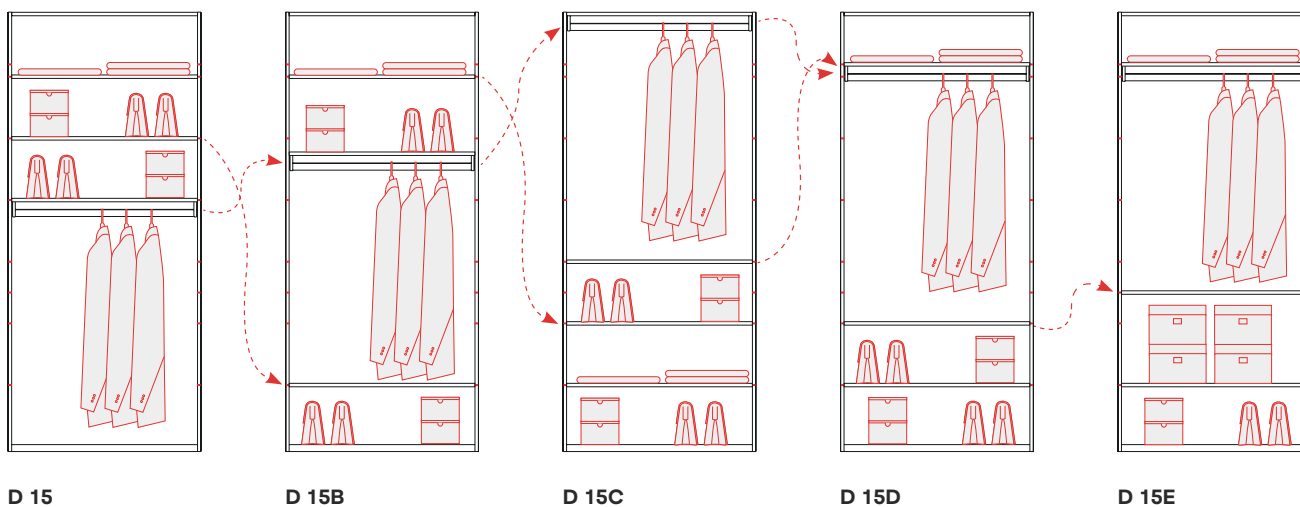

The modules can be customized according to their intended use.



M 03  
ALFA  
Jewelry Organizer and  
Trousers Hanger



M 15  
ALFA  
Hidden Compartment  
Module



M 16  
ALFA  
Short Drawers  
Module



M 05  
ALFA  
Long Shelf Module  
With Rack

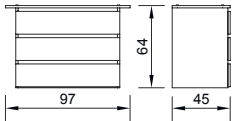

**M 01**

**ALFA**  
DRAWERS  
MODULE

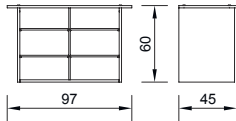

**M 02**

**ALFA**  
T-SHIRT  
ORGANIZER  
MODULE

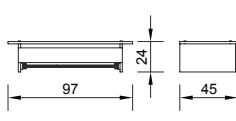

**M 03**

**ALFA**  
JEWELLRY  
ORGANIZER  
AND TROUSER  
RACK MODULE

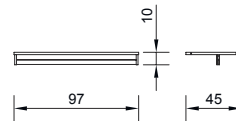

**M 04**

**ALFA**  
LONG SHELF  
MODULE WITH  
HANGER

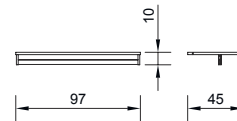

**M 05**

**ALFA**  
LONG SHELF  
MODULE WITH  
HANGER 2  
PCS.



**M 06**

**ALFA**  
LONG SHELF  
MODULE

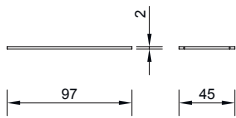
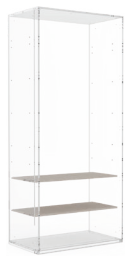

**M 07**

**ALFA**  
LONG SHELF  
MODULE 2  
PCS.

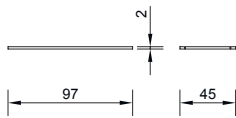

**M 08**

**ALFA**  
LONG SHELF  
MODULE 3  
PCS.

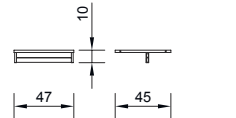
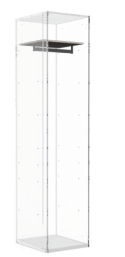

**M 09**

**ALFA**  
SHORT SHELF  
MODULE WITH  
HANGER

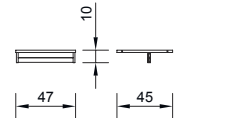

**M 10**

**ALFA**  
SHORT SHELF  
MODULE WITH  
HANGER 2  
PCS.

**M01/ALFA/Drawers Module:** Consists of three deep and wide drawers with telescopic rails. Drawer bottoms are 8 mm thick.

**M02/ALFA/T-shirt organizer Module:** Ideal storage unit for shirts and sweaters, with six compartments made of 8 mm rails.

**M03/ALFA/Jewelry Organizer and Trousers Rack Module:** An organizer with eight compartments for jewelry and a rail system for hanging up to seven pants. The material is coated with elastomer for slip resistance.

**M04/M05/ALFA/Long shelf Module with Hanger:** Features a non-slip, noiseless aluminum hanging tube coated with elastomer, with a length of 97 cm.

**M06/M07/M08/ALFA/Long Shelf Module:** Consists of shelves with a length of 97 cm, connected with 18 mm-thick rafix connectors.

**M09/M10/ALFA/Short Shelf module with Hanger:** A 47 cm-long module with a non-slip, noiseless aluminum hanging tube coated with elastomer.

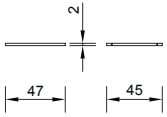

**M 11**

**ALFA**  
SHORT SHELF  
MODULE

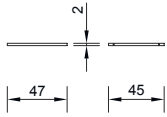
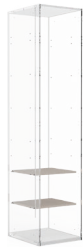

**M 12**

**ALFA**  
SHORT SHELF  
MODULE  
2 PCS.

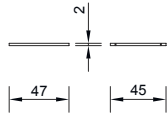

**M 13**

**ALFA**  
SHORT SHELF  
MODULE  
3 PCS.

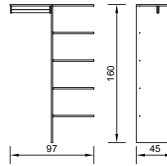

**M 14**

**ALFA**  
SEPARATOR  
MODULE WITH  
SHELVES

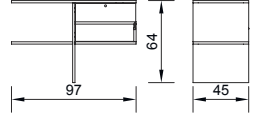

**M 15**

**ALFA**  
HIDDEN  
COMPARTMENT  
MODULE

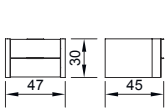

**M 16**

**ALFA**  
SHORT  
DRAWERS  
MODULE

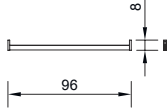

**M 17**

**ALFA**  
LONG  
HANGER

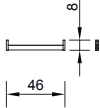

**M 18**

**ALFA**  
SHORT  
HANGER

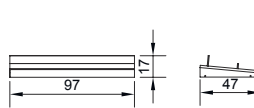
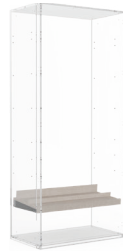

**M 19**

**ALFA**  
SHOES  
ORGANIZER  
MODULE

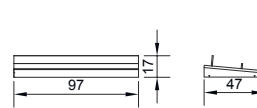

**M 20**

**ALFA**  
SHOES  
ORGANIZER  
MODULE 2  
PCS.

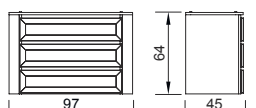

**M 21**

**ALFA**  
GLASS  
DRAWER  
MODULE

**M11/M12/M13/ALFA/Short Shelf Module:**  
Features 18 mm-thick rafix connectors, with shelves 47 cm in length.

**M14/ALFA/Separator Module with Shelves:**  
A module suitable for hanging long dresses, with five compartments for storing sweaters and shirts.

**M15/ALFA/Hidden Compartment Module:**  
A unit with a fingerprint and password-protected lock system designed to store your personal belongings securely.

**M16/ALFA/Short Drawers Module:**  
A telescopic rail system module for fitting into narrow spaces between shelves.

**M17/M18/ALFA/Long and Short Hangers:**  
A module consisting of non-slip, scratch-resistant, and noiseless elastomer-coated hanging tubes suitable for attaching to all upper panels in ALFA modules. Available in sizes 96 cm and 46 cm.

**M19/M20/ALFA/Shoes Organizer Modules:**  
An open structure module for storing all types of shoes, with two rows. Suitable for installation in double-door cabinets.

**M21/ALFA/Glass Drawer Module**

**M22/ALFA/Aluminium Long Shelf Module**

**M23/ALFA/8-Lead Adapter Module**

# 06

## DESIGN YOUR OWN WARDROBE

### ALFA OFFERS ALL USERS THE FREEDOM TO DESIGN THEIR OWN WARDROBE OR DRESSING ROOM

By placing the inside modules as you wish into the holes drilled on the right and left sides, you can create the most suitable cabinet for yourself. With this feature in single and double body cabinets, ALFA allows you to determine an unlimited number of cabinet options.

On the following pages, you can review our recommendations for the cabinet that is closest to ideal, and make your decision comfortably.



The inside structure of D 09 and D 10 are standart, they can only change by size.

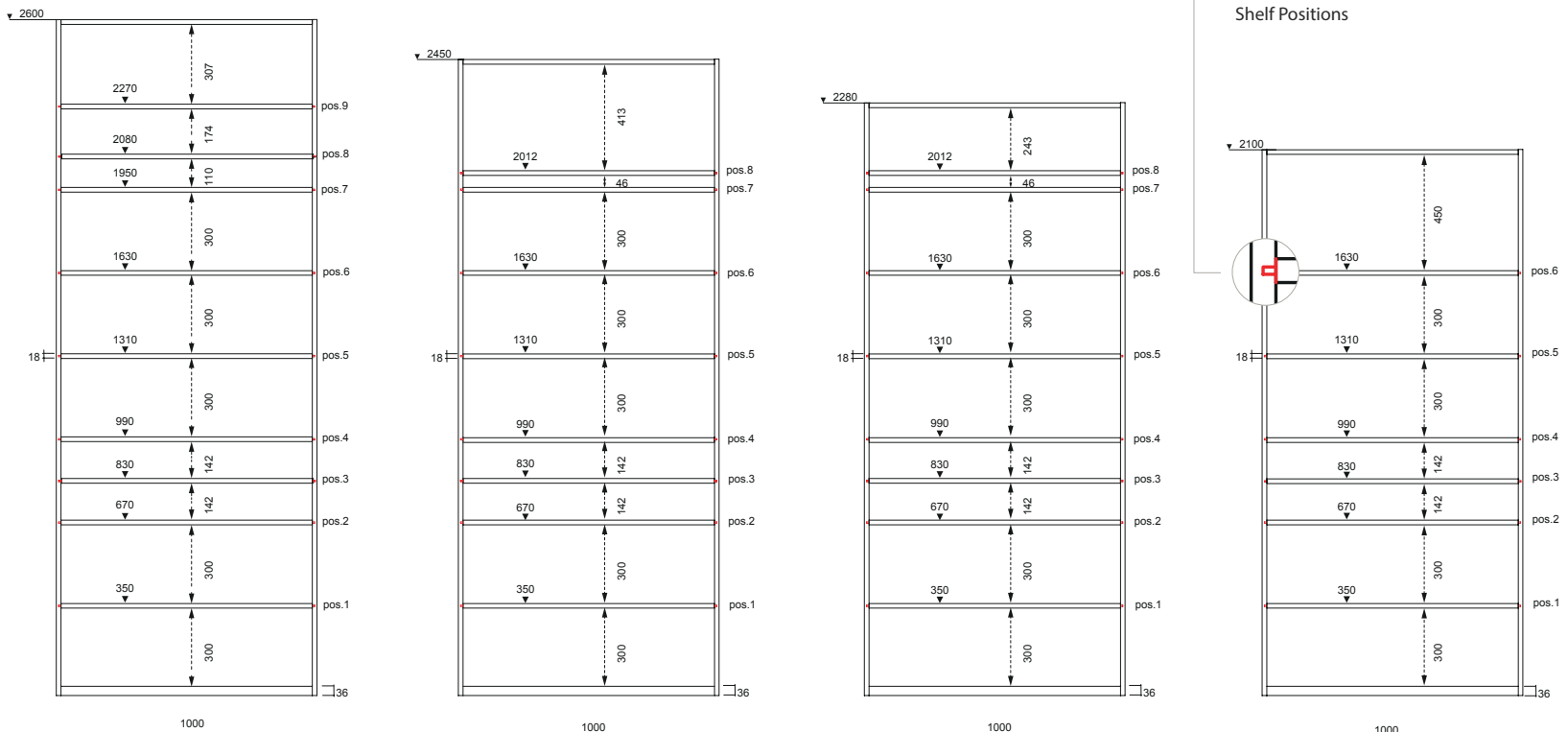

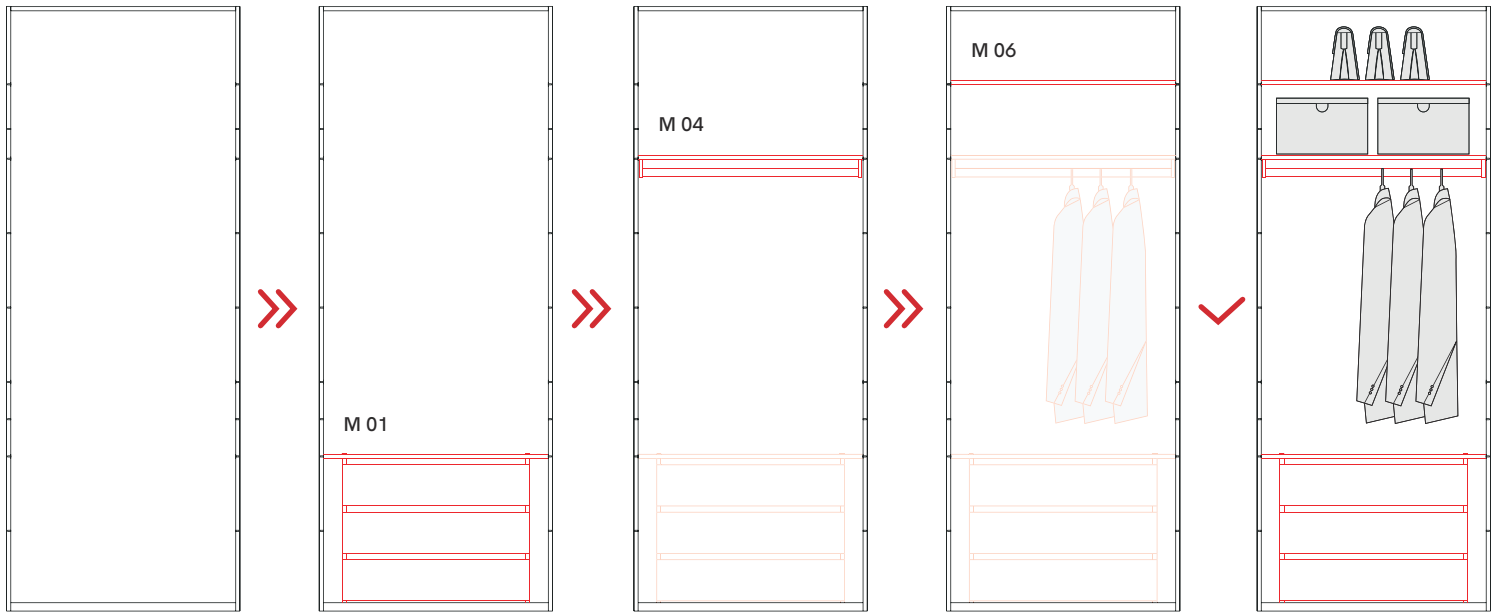

G 02  
ALFA  
DOUBLE MAIN  
CABINET

**STEP 1**

M 01  
ALFA  
DRAWERS  
MODULE

**STEP 2**

M 04  
ALFA  
LONG SHELF  
MODULE  
WITH HANGER

**STEP 3**

M 06  
ALFA  
LONG SHELF  
MODULE

**STEP 4**

D 02  
ALFA  
DOUBLE CABINET WITH  
DRAWERS MODULE

G 02-260 1 pc.  
M 01 1 pc.  
M 04 1 pc.  
M 06 1 pc.

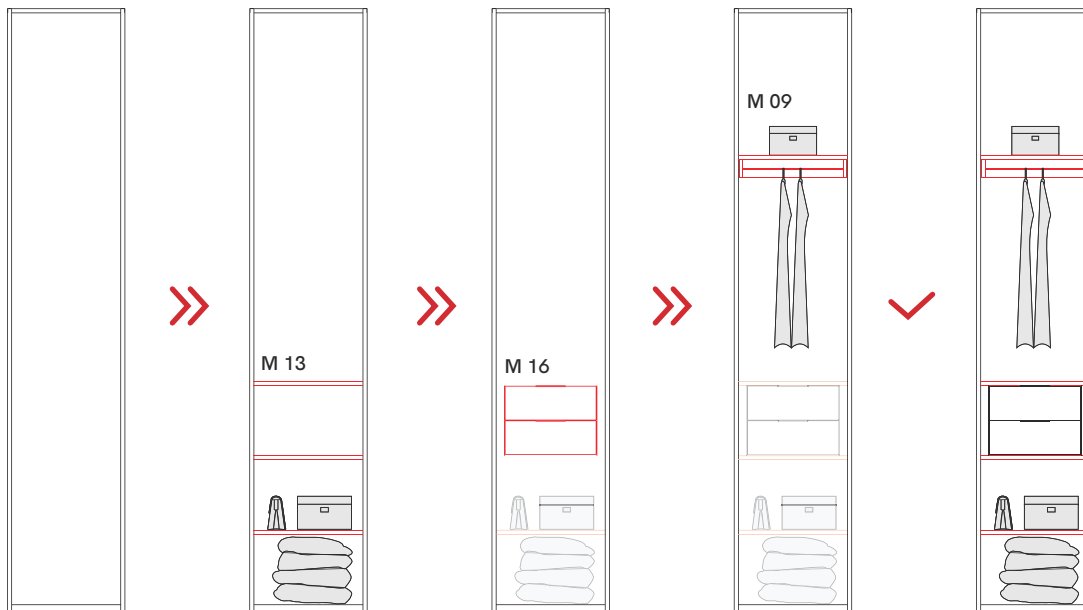

G 01  
ALFA  
DOUBLE MAIN  
CABINET

**STEP 1**

M 13  
ALFA  
SHORT SHELF  
MODULE 3 PCS.

**STEP 2**

M 16  
ALFA  
SHORT DRAWERS  
MODULE

**STEP 3**

M 09  
ALFA  
SHORT SHELF  
MODULE WITH  
HANGER

**STEP 4**

D 18  
ALFA  
SINGLE CABINET WITH  
DRAWERS MODULE

G 01-260 1 pc.  
M 16 1 pc.  
M 13 1 pc.  
M 09 1 pc.

# 210 CM

## Our Suggestions



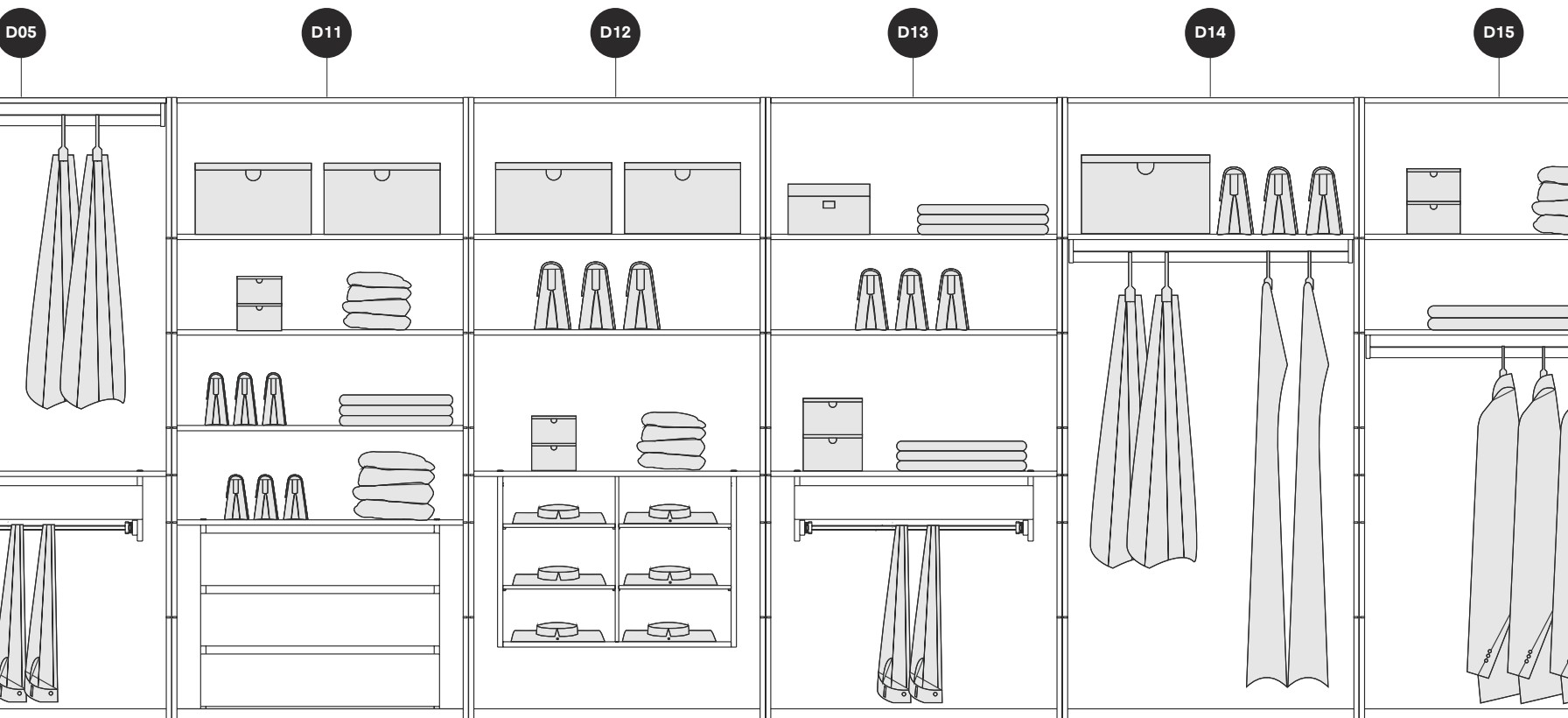

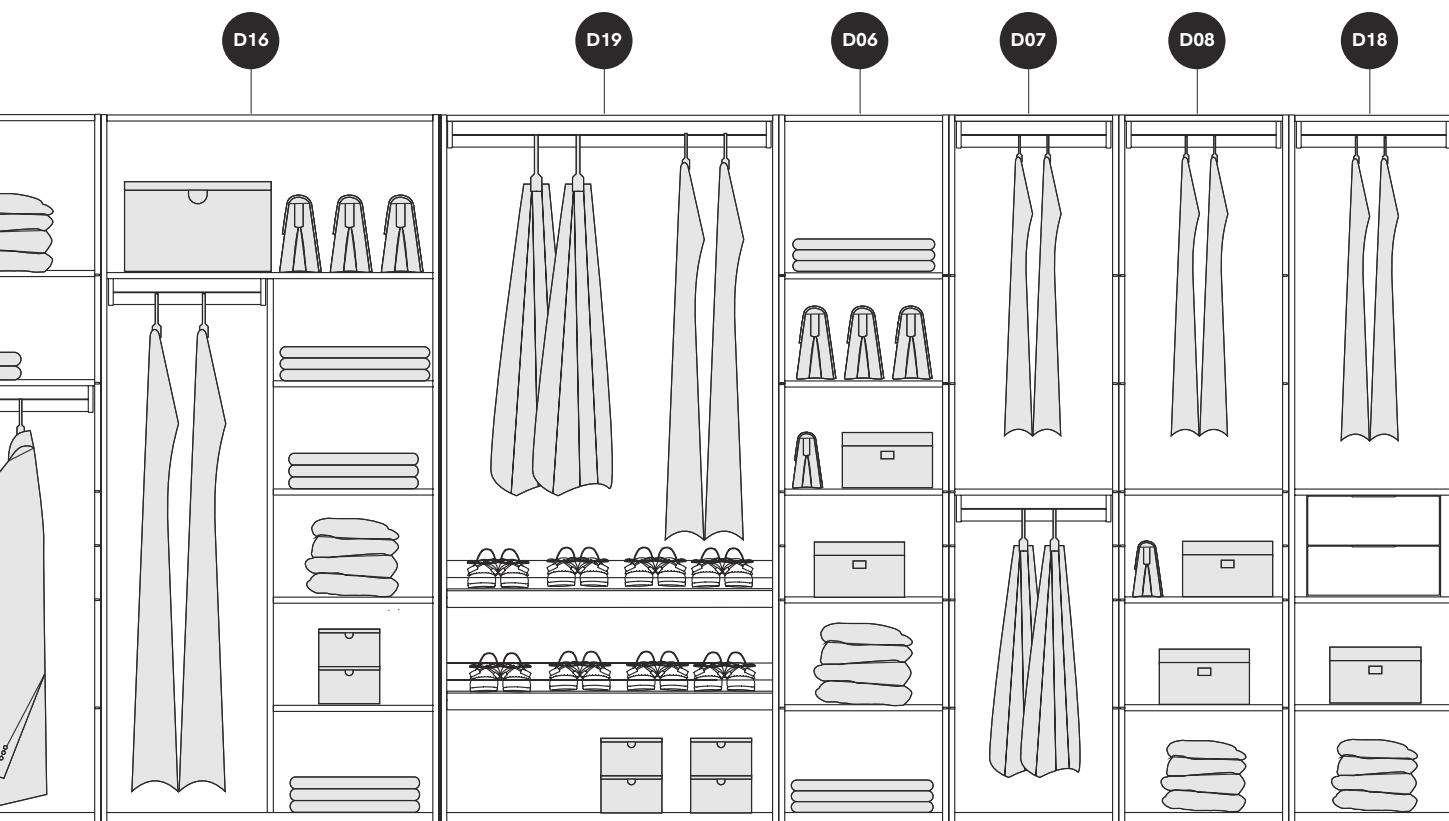

"Your wardrobe is a part  
of your lifestyle"



# ALFA 210 CM Wardrobe Modules

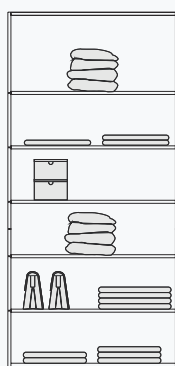

## D 01-210

ALFA  
**DOUBLE  
CABINET WITH  
5 SHELVES**

Content of this Order;

G 02-210 1 pc.  
M 07 1 pc.  
M 08 1 pc.

Consists of  
these modules.

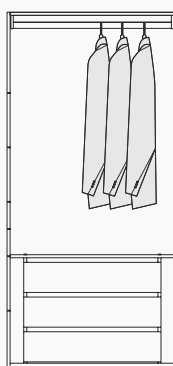

## D 02-210

ALFA  
**DOUBLE  
CABINET WITH  
DRAWERS  
MODULE**

Content of this Order;

G 02-210 1 pc.  
M 01 1 pc.  
M 17 1 pc.

Consists of  
these modules.



## D 03-210

ALFA  
**DOUBLE  
CABINET  
WITH  
HANGER**

Content of this Order;

G 02-210 1 pc.  
M 04 1 pc.  
M 17 1 pc.

Consists of  
these modules.

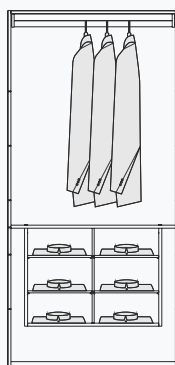

## D 04-210

ALFA  
**DOUBLE  
CABINET  
WITH T-SHIRT  
ORGANIZER**

Content of this Order;

G 02-210 1 pc.  
M 02 1 pc.  
M 17 1 pc.

Consists of these  
modules.

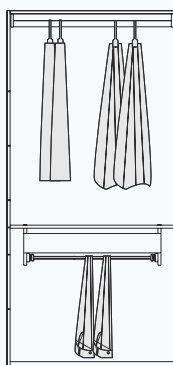

## D 05-210

ALFA  
**DOUBLE CABINET  
WITH TROUSER  
RACK**

Content of this Order;

G 02-210 1 pc.  
M 03 1 pc.  
M 17 1 pc.

Consists of these  
modules.



## D 06-210

ALFA  
**SINGLE  
CABINET WITH  
5 SHELVES**

Content of this Order;

G 01-210 1 pc.  
M 12 1 pc.  
M 13 1 pc.

Consists of these  
modules.

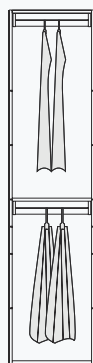

## D 07-210

ALFA  
**SINGLE  
CABINET  
WITH  
HANGER**

Content of this Order;

G 01-210 1 pc.  
M 18 1 pc.  
M 09 1 pc.

Consists of these  
modules.

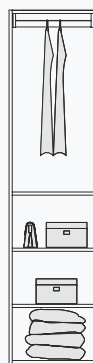

## D 08-210

ALFA  
**SINGLE  
CABINET  
WITH  
3 SHELVES  
AND  
A HANGER**

Content of this Order;

G 01-210 1 pc.  
M 09 1 pc.  
M 13 1 pc.

Consists of these  
modules.

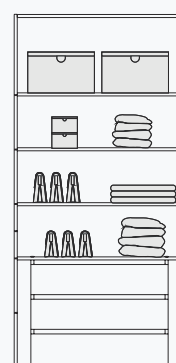

## D 11-210

ALFA  
**DOUBLE  
CABINET WITH  
4 SHELVES  
AND DRAWERS  
MODULE**

Content of this Order;

G 02-210 1 pc.  
M 01 1 pc.  
M 08 1 pc.

Consists of these  
modules.

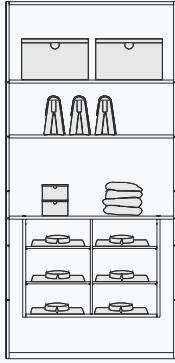

### D 12-210

ALFA  
**DOUBLE  
CABINET  
WITH T-SHIRT  
ORGANIZER**

Content of this Order;  
G 02-210 1 pc.  
M 02 1 pc.  
M 07 1 pc.  
Consists of these  
modules.



### D 13-210

ALFA  
**CABINET  
WITH  
TROUSER  
RACK**

Content of this Order;  
G 02-210 1 pc.  
M 03 1 pc.  
M 07 1 pc.  
Consists of these  
modules.

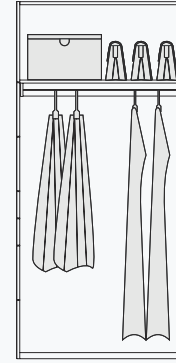

### D 14-210

ALFA  
**DOUBLE  
CABINET WITH  
SINGLE SHELF**

Content of this Order;  
G 02-210 1 pc.  
M 04 1 pc.  
Consists of these  
modules.

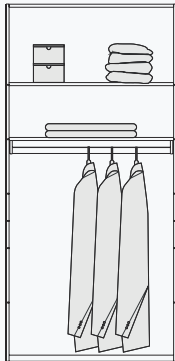

### D 15-210

ALFA  
**DOUBLE  
CABINET WITH  
A SHELF**

Content of this Order;  
G 02-210 1 pc.  
M 04 1 pc.  
M 06 1 pc.  
Consists of these  
modules.

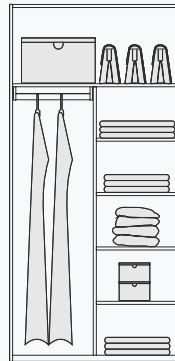

### D 16-210

ALFA  
**DOUBLE  
CABINET WITH  
SEPARATOR  
MODULE AND  
SHELVES**

Content of this Order;  
G 02-210 1 pc.  
M 14 1 pc.  
Consists of these  
modules.

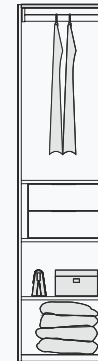

### D 18-210

ALFA  
**SINGLE  
CABINET  
WITH  
DRAWERS  
MODULE**

Content of this Order;  
G 01-210 1 pc.  
M 16 1 pc.  
M 13 1 pc.  
M 09 1 pc.  
Consists of these  
modules.

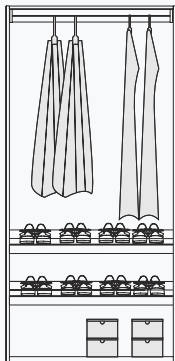

### D 19-210

ALFA  
**DOUBLE  
CABINET  
WITH SHOES  
ORGANIZER**

Content of this Order;  
G 02-210 1 pc.  
M 20 1 pc.  
M 17 1 pc.  
Consists of these  
modules.

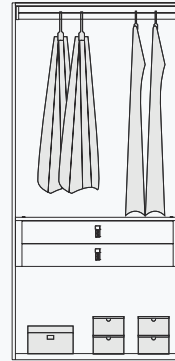

### D 20-210

ALFA  
**DOUBLE  
CABINET  
WITH TWO  
DRAWER MODULE  
AND HANGER**

Content of this Order;  
G 02-210 1 pc.  
M 17 1 pc.  
M 25 1 pc.  
Consists of these  
modules.

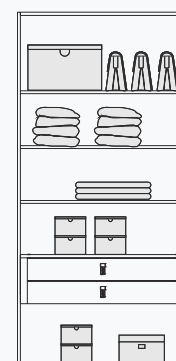

### D 21-210

ALFA  
**DOUBLE  
CABINET  
WITH TWO  
DRAWER  
MODULE AND  
SHELVES**

Content of this Order;  
G 02-210 1 pc.  
M 08 1 pc.  
M 25 1 pc.  
Consists of these  
modules.



### D 22-210

ALFA  
**DOUBLE  
CABINET  
WITH LEATHER  
JEWELLERY BOX  
AND SHELVES**

Content of this Order;  
G 02-210 1 pc.  
M 26 1 pc.  
M 07 1 pc.  
Consists of these  
modules.

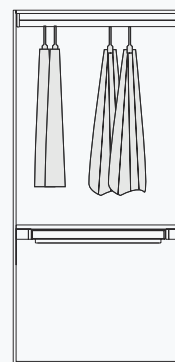

### D 23-210

ALFA  
**DOUBLE  
CABINET  
WITH LEATHER  
JEWELLERY BOX  
AND HANGER**

Content of this Order;  
G 02-210 1 pc.  
M 26 1 pc.  
M 17 1 pc.  
Consists of these  
modules.

# 228 CM Our Suggestions



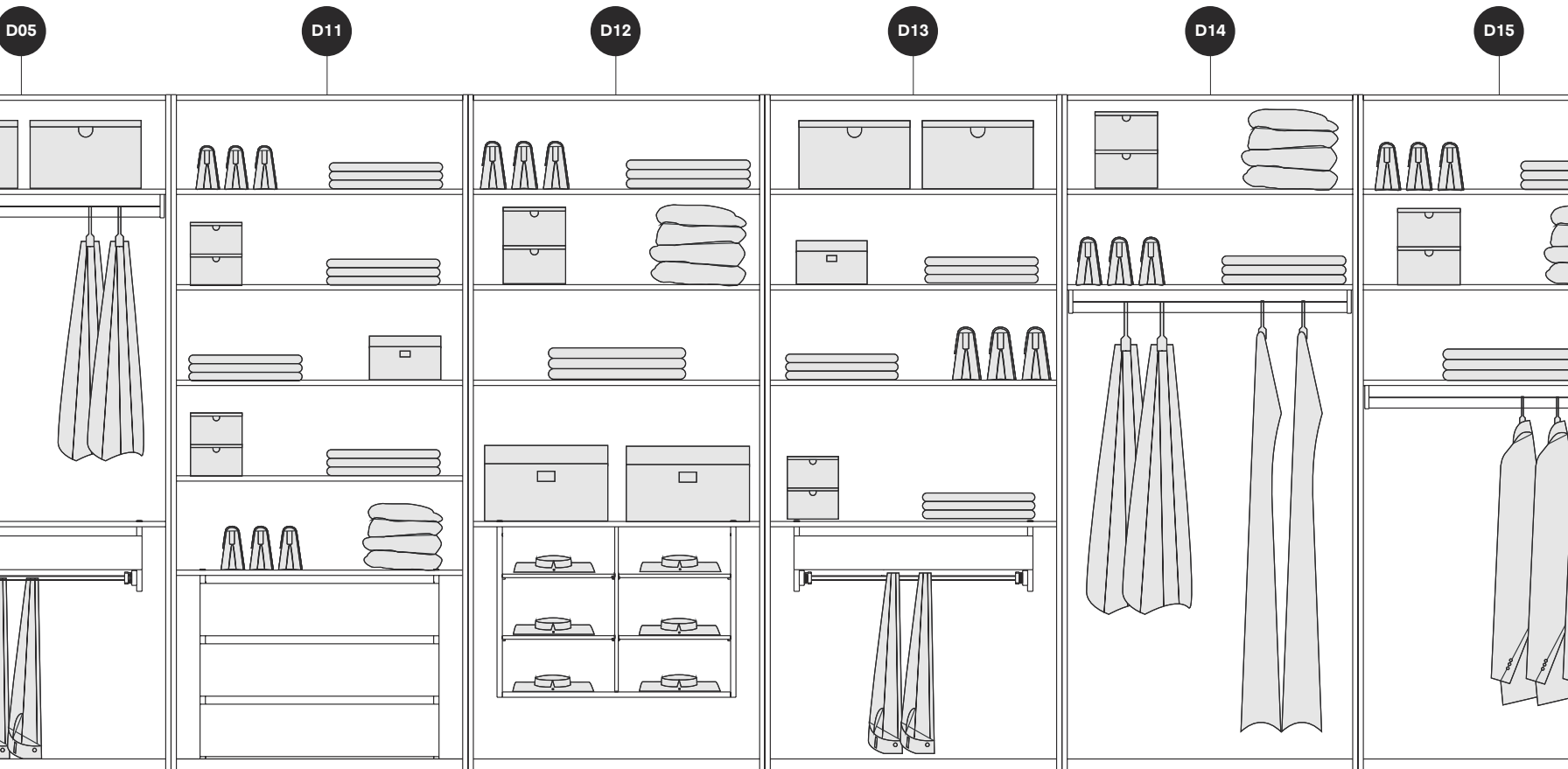

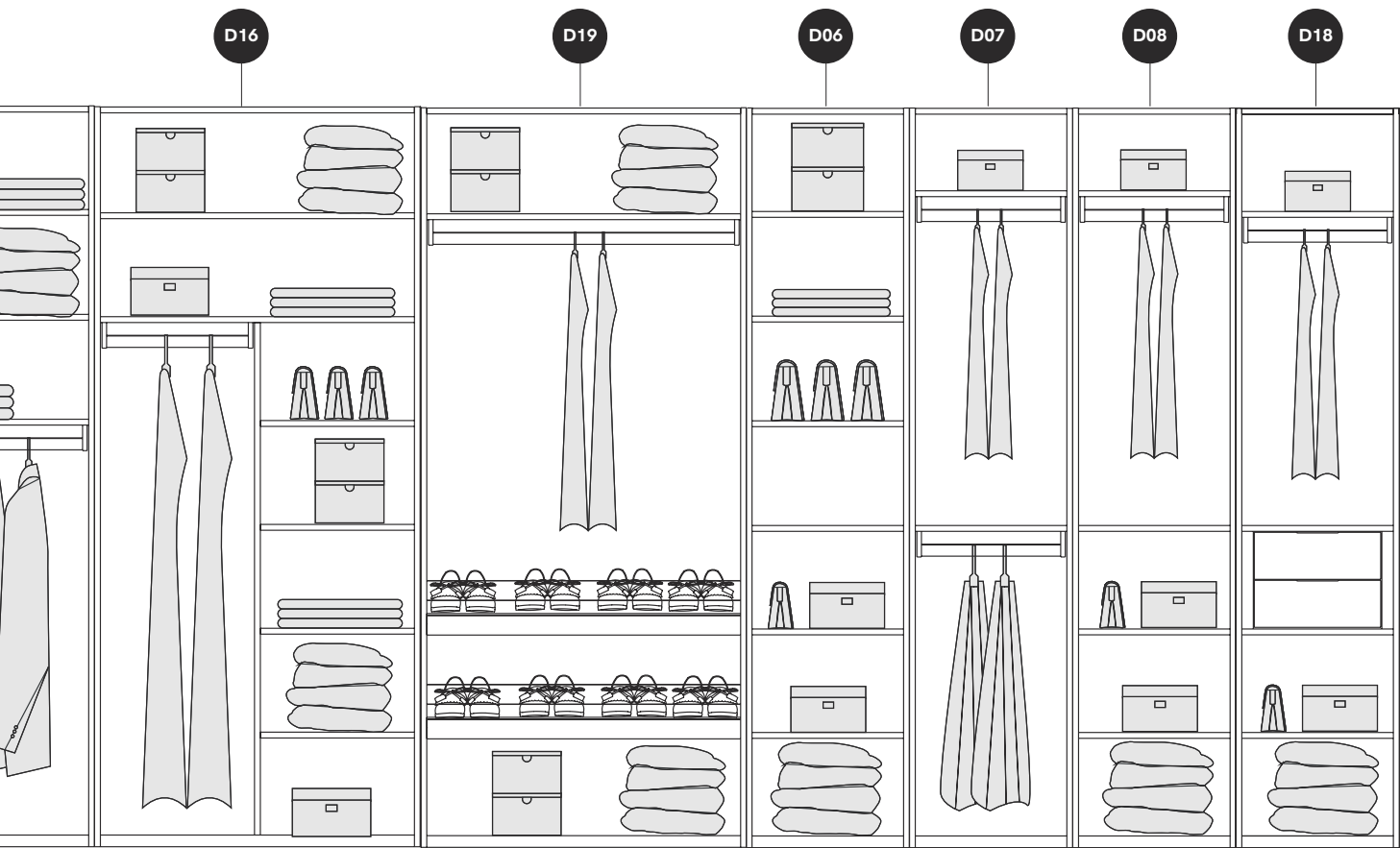

“Personalize ALFA as  
you wish”



# ALFA 228 CM Wardrobe Modules

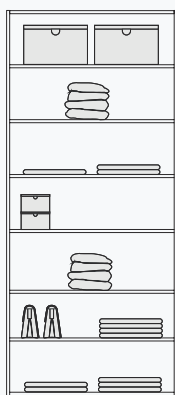

## D 01-228

ALFA  
DOUBLE  
CABINET  
WITH  
5 SHELVES

Content of this Order;

G 02-228 1 pc.  
M 08 2 pcs.

Consists of these modules.

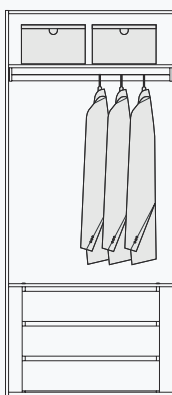

## D 02-228

ALFA  
DOUBLE  
CABINET WITH  
DRAWERS  
MODULE

Content of this Order;

G 02-228 1 pc.  
M 01 1 pc.  
M 04 1 pc.

Consists of these modules.



## D 03-228

ALFA  
DOUBLE  
CABINET  
WITH HANGER

Content of this Order;

G 02-228 1 pc.  
M 05 1 pc.

Consists of these modules.

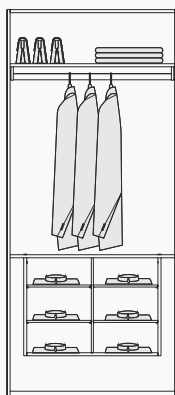

## D 04-228

ALFA  
DOUBLE  
CABINET  
WITH T-SHIRT  
ORGANIZER

Content of this Order;

G 02-228 1 pc.  
M 04 1 pc.  
M 02 1 pc.

Consists of these modules.

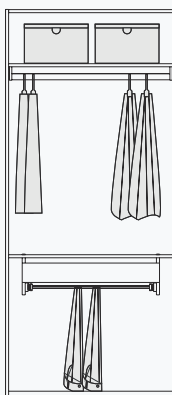

## D 05-228

ALFA  
DOUBLE  
CABINET  
WITH  
TROUSER  
RACK

Content of this Order;

G 02-228 1 pc.  
M 04 1 pc.  
M 03 1 pc.

Consists of these modules.



## D 06-228

ALFA  
SINGLE  
CABINET  
WITH  
5 SHELVES

Content of this Order;

G 01-228 1 pc.  
M 13 2 pcs.

Consists of these modules.

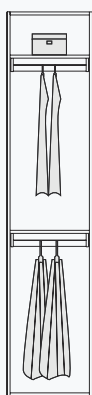

## D 07-228

ALFA  
SINGLE  
CABINET  
WITH  
HANGER

Content of this Order;

G 01-228 1 pc.  
M 10 1 pc.

Consists of these modules.

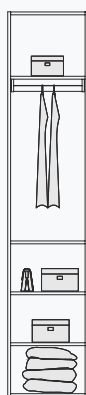

## D 08-228

ALFA  
SINGLE  
CABINET  
WITH  
3 SHELVES  
AND  
A HANGER

Content of this Order;

G 01-228 1 pc.  
M 09 1 pc.  
M 13 1 pc.

Consists of these modules.

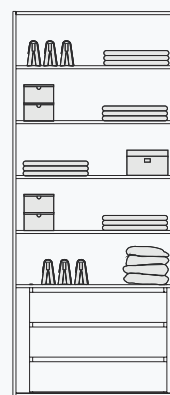

## D 11-228

ALFA  
DOUBLE  
CABINET WITH  
4 SHELVES  
AND DRAWERS  
MODULE

Content of this Order;

G 02-228 1 pc.  
M 01 1 pc.  
M 07 2 pc.

Consists of these modules.

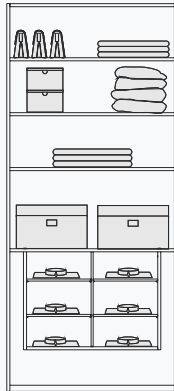
**D 12-228**

ALFA  
**DOUBLE  
CABINET  
WITH T-SHIRT  
ORGANIZER**

Content of this Order;

G 02-228 1 pc.  
M 02 1 pc.  
M 08 1 pc.

Consists of  
these modules.

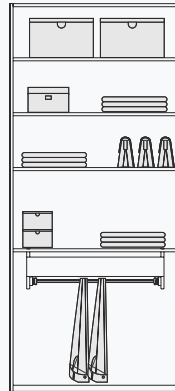
**D 13-228**

ALFA  
**CABINET  
WITH TROUSER  
RACK**

Content of this Order;

G 02-228 1 pc.  
M 03 1 pc.  
M 08 1 pc.

Consists of  
these modules.

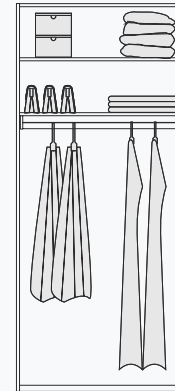

ALFA  
**DOUBLE  
CABINET  
WITH  
SINGLE  
SHELF**

Content of this Order;

G 02-228 1 pc.  
M 04 1 pc.  
M 06 1 pc.

Consists of  
these modules.

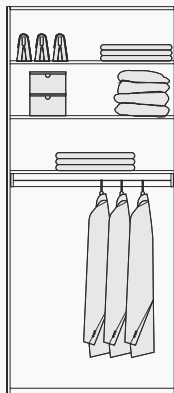
**D 15-228**

ALFA  
**DOUBLE  
CABINET WITH  
A SHELF**

Content of this Order;

G 02-228 1 pc.  
M 04 1 pc.  
M 07 1 pc.

Consists of these  
modules.

**D 16-228**

ALFA  
**DOUBLE  
CABINET WITH  
SEPARATOR  
MODULE AND  
SHELVES**

Content of this Order;

G 02-228 1 pc.  
M 14 1 pc.  
M 06 1 pc.

Consists of these  
modules.



ALFA  
**SINGLE  
CABINET  
WITH  
DRAWERS  
MODULE**

Content of this Order;

G 01-228 1 pc.  
M 16 1 pc.  
M 13 1 pc.  
M 09 1 pc.

Consists of these  
modules.

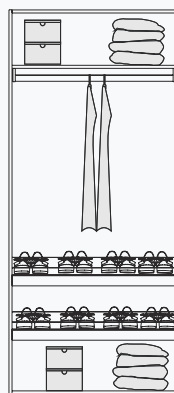
**D 19-228**

ALFA  
**DOUBLE  
CABINET  
WITH SHOES  
ORGANIZER**

Content of this Order;

G 02-228 1 pc.  
M 20 1 pc.  
M 04 1 pc.

Consists of  
these modules.

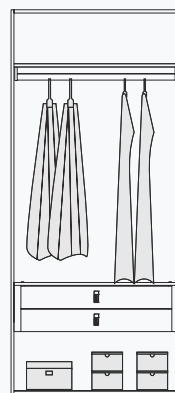
**D 20-228**

ALFA  
**DOUBLE  
CABINET  
WITH TWO DRAWER  
MODULE AND  
HANGER**

Content of this Order;

G 02-228 1 pc.  
M 04 1 pc.  
M 25 1 pc.

Consists of these  
modules.

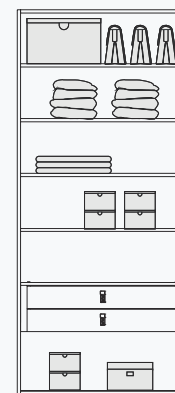
**D 21-228**

ALFA  
**DOUBLE  
CABINET  
WITH TWO DRAWER  
MODULE AND  
SHELVES**

Content of this Order;

G 02-228 1 pc.  
M 07 2 pc.  
M 25 1 pc.

Consists of these  
modules.

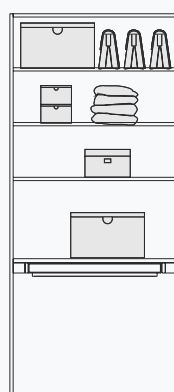
**D 22-228**

**DOUBLE  
CABINET  
WITH LEATHER  
JEWELLERY  
BOX  
AND SHELVES**

Content of this Order;

G 02-228 1 pc.  
M 26 1 pc.  
M 08 1 pc.

Consists of these  
modules.

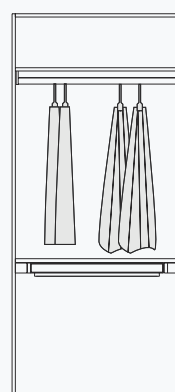
**D 23-228**

ALFA  
**DOUBLE  
CABINET  
WITH LEATHER  
JEWELLERY  
BOX  
AND HANGER**

Content of this Order;

G 02-228 1 pc.  
M 26 1 pc.  
M 04 1 pc.

Consists of these  
modules.

# 245 CM Our Suggestions



D05

D11

D12

D13

D14

D15

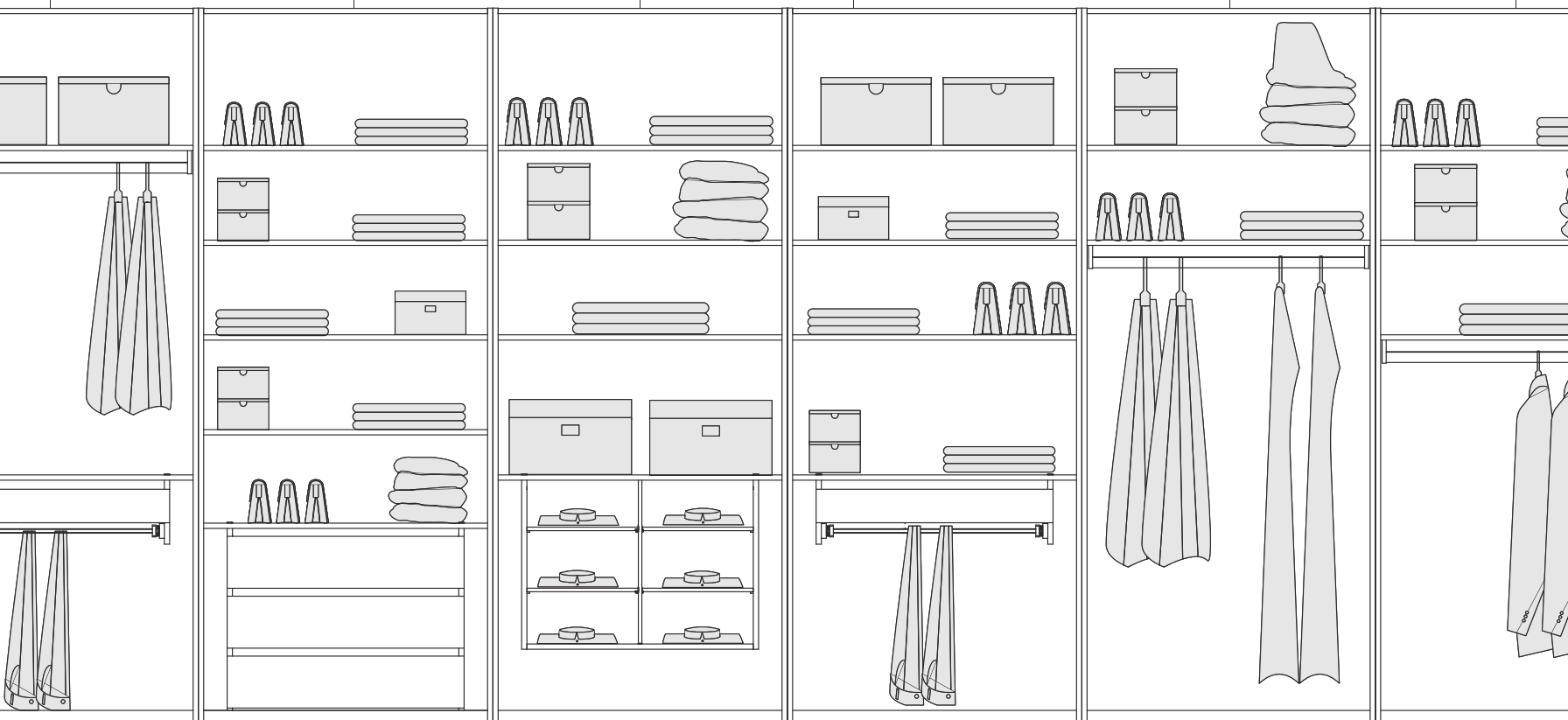

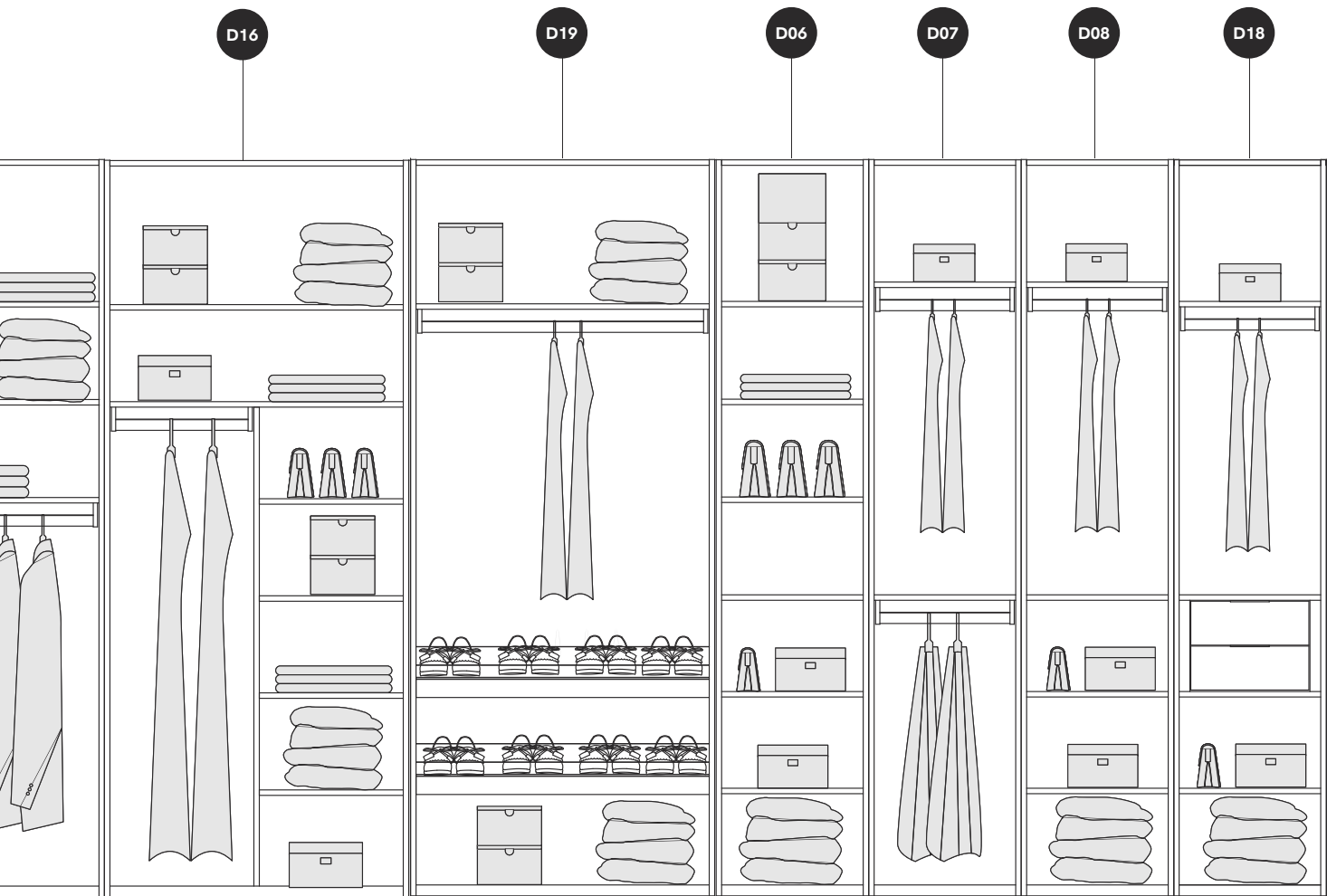

“The place for every piece  
of your clothing is here”



# ALFA 245 CM Wardrobe Modules

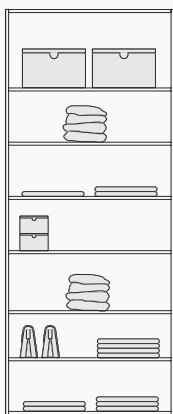

## D 01-245

ALFA  
DOUBLE  
CABINET  
WITH  
5 SHELVES

Content of this Order;

G 02-245 1 pc.  
M 08 2 pcs.

Consists of these modules.

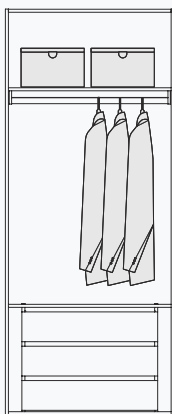

## D 02-245

ALFA  
DOUBLE  
CABINET WITH  
DRAWERS  
MODULE

Content of this Order;

G 02-245 1 pc.  
M 01 1 pc.  
M 04 1 pc.

Consists of these modules.



## D 03-245

ALFA  
DOUBLE  
CABINET  
WITH  
HANGER

Content of this Order;

G 02-245 1 pc.  
M 05 1 pc.

Consists of these modules.

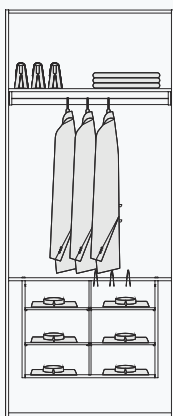

## D 04-245

ALFA  
DOUBLE  
CABINET  
WITH T-SHIRT  
ORGANIZER

Content of this Order;

G 02-245 1 pc.  
M 04 1 pc.  
M 02 1 pc.

Consists of these modules.

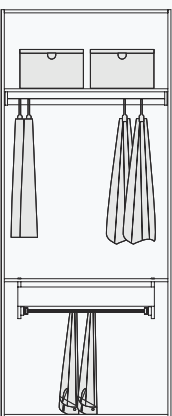

## D 05-245

ALFA  
DOUBLE CABINET  
WITH TROUSER  
RACK

Content of this Order;

G 02-245 1 pc.  
M 04 1 pc.  
M 03 1 pc.

Consists of these modules.



## D 06-245

ALFA  
SINGLE  
CABINET  
WITH  
5 SHELVES

Content of this Order;

G 01-245 1 pc.  
M 13 2 pcs.

Consists of these modules.

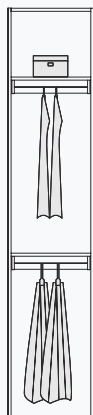

## D 07-245

ALFA  
SINGLE  
CABINET  
WITH  
HANGER

Content of this Order;

G 01-245 1 pc.  
M 10 1 pc.

Consists of these modules.

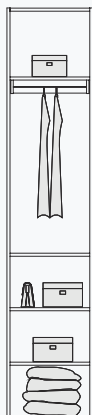

## D 08-245

ALFA  
SINGLE  
CABINET  
WITH  
3 SHELVES  
AND  
A HANGER

Content of this Order;

G 01-245 1 pc.  
M 09 1 pc.  
M 13 1 pc.

Consists of these modules.

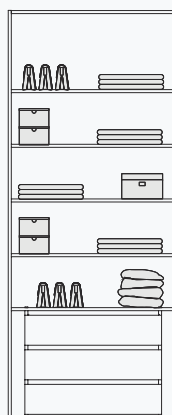

## D 11-245

ALFA  
DOUBLE  
CABINET WITH  
4 SHELVES  
AND DRAWERS  
MODULE

Content of this Order;

G 02-245 1 pc.  
M 01 1 pc.  
M 07 2 pc.

Consists of these modules.

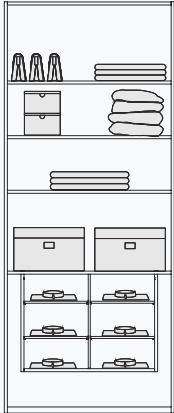

### D 12-245

ALFA  
**DOUBLE  
CABINET  
WITH T-SHIRT  
ORGANIZER**

Content of this Order;

G 02-245 1 pc.  
M 02 1 pc.  
M 08 1 pc.

Consists of  
these modules.

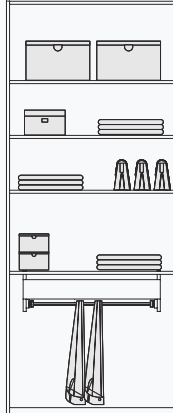

### D 13-245

ALFA  
**CABINET  
WITH TROUSER  
RACK**

Content of this Order;

G 02-245 1 pc.  
M 03 1 pc.  
M 08 1 pc.

Consists of  
these modules.

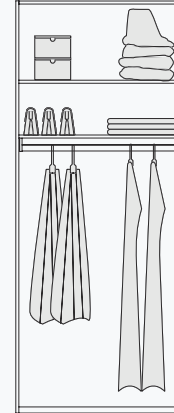

### D 14-245

ALFA  
**DOUBLE  
CABINET  
WITH  
SINGLE  
SHELF**

Content of this Order;

G 02-245 1 pc.  
M 04 1 pc.  
M 06 1 pc.

Consists of  
these modules.

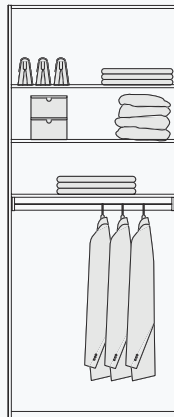

### D 15-245

ALFA  
**DOUBLE  
CABINET WITH  
A SHELF**

Content of this Order;

G 02-245 1 pc.  
M 04 1 pc.  
M 07 1 pc.

Consists of these  
modules.

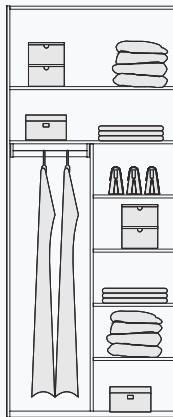

### D 16-245

ALFA  
**DOUBLE  
CABINET WITH  
SEPARATOR  
MODULE AND  
SHELVES**

Content of this Order;

G 02-245 1 pc.  
M 14 1 pc.  
M 06 1 pc.

Consists of these  
modules.

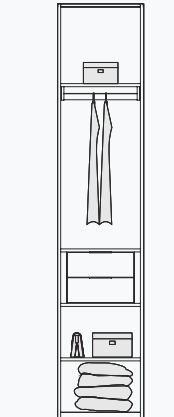

### D 18-245

ALFA  
**SINGLE  
CABINET  
WITH  
DRAWERS  
MODULE**

Content of this Order;

G 01-245 1 pc.  
M 16 1 pc.  
M 13 1 pc.  
M 09 1 pc.

Consists of these  
modules.

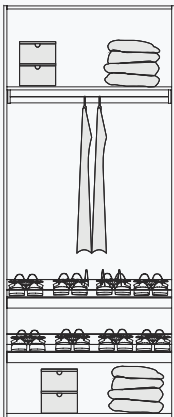

### D 19-245

ALFA  
**DOUBLE  
CABINET  
WITH SHOES  
ORGANIZER**

Content of this Order;

G 02-245 1 pc.  
M 20 1 pc.  
M 04 1 pc.

Consists of  
these modules.

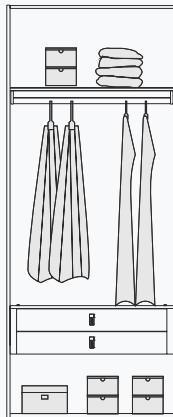

### D 20-245

ALFA  
**DOUBLE  
CABINET  
WITH TWO DRAWER  
MODULE AND  
HANGER**

Content of this Order;

G 02-228 1 pc.  
M 04 1 pc.  
M 25 1 pc.

Consists of these  
modules.

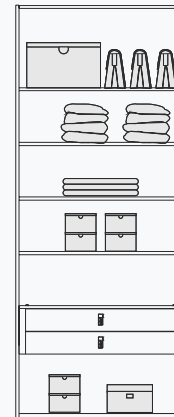

### D 21-245

ALFA  
**DOUBLE  
CABINET  
WITH TWO DRAWER  
MODULE AND  
SHELVES**

Content of this Order;

G 02-228 1 pc.  
M 07 2 pc.  
M 25 1 pc.

Consists of these  
modules.

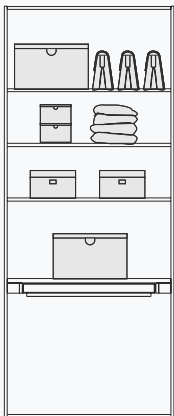

### D 22-245

**DOUBLE  
CABINET  
WITH LEATHER  
JEWELLERY  
BOX  
AND SHELVES**

Content of this Order;

G 02-245 1 pc.  
M 26 1 pc.  
M 08 2 pc.

Consists of these  
modules.

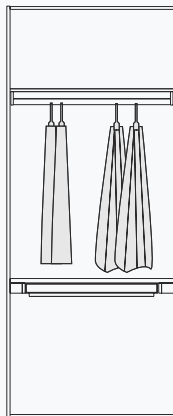

### D 23-245

ALFA  
**DOUBLE  
CABINET  
WITH LEATHER  
JEWELLERY  
BOX  
AND HANGER**

Content of this Order;

G 02-245 1 pc.  
M 26 1 pc.  
M 04 1 pc.

Consists of these  
modules.

# 260 CM

## Our Suggestions

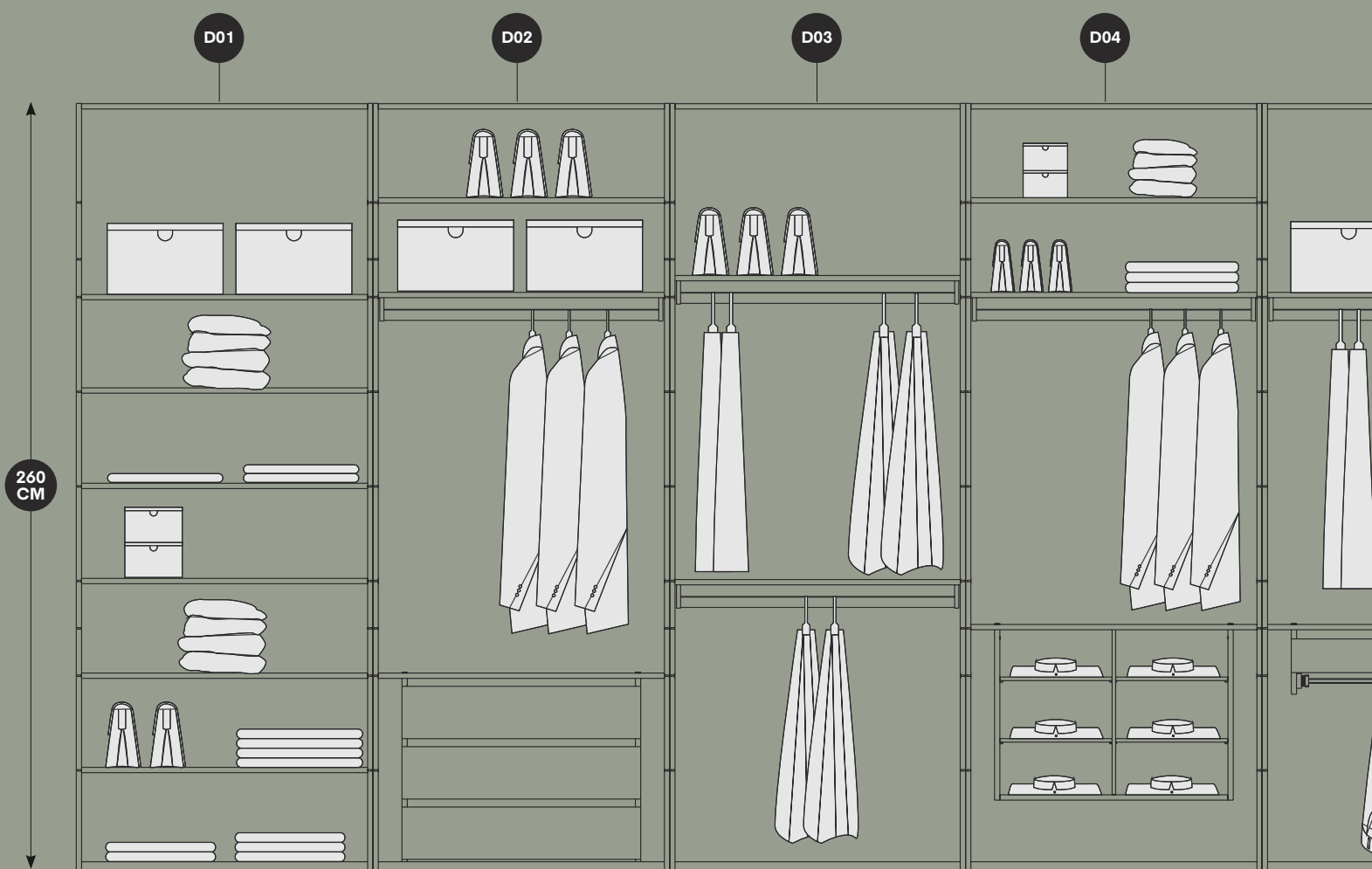

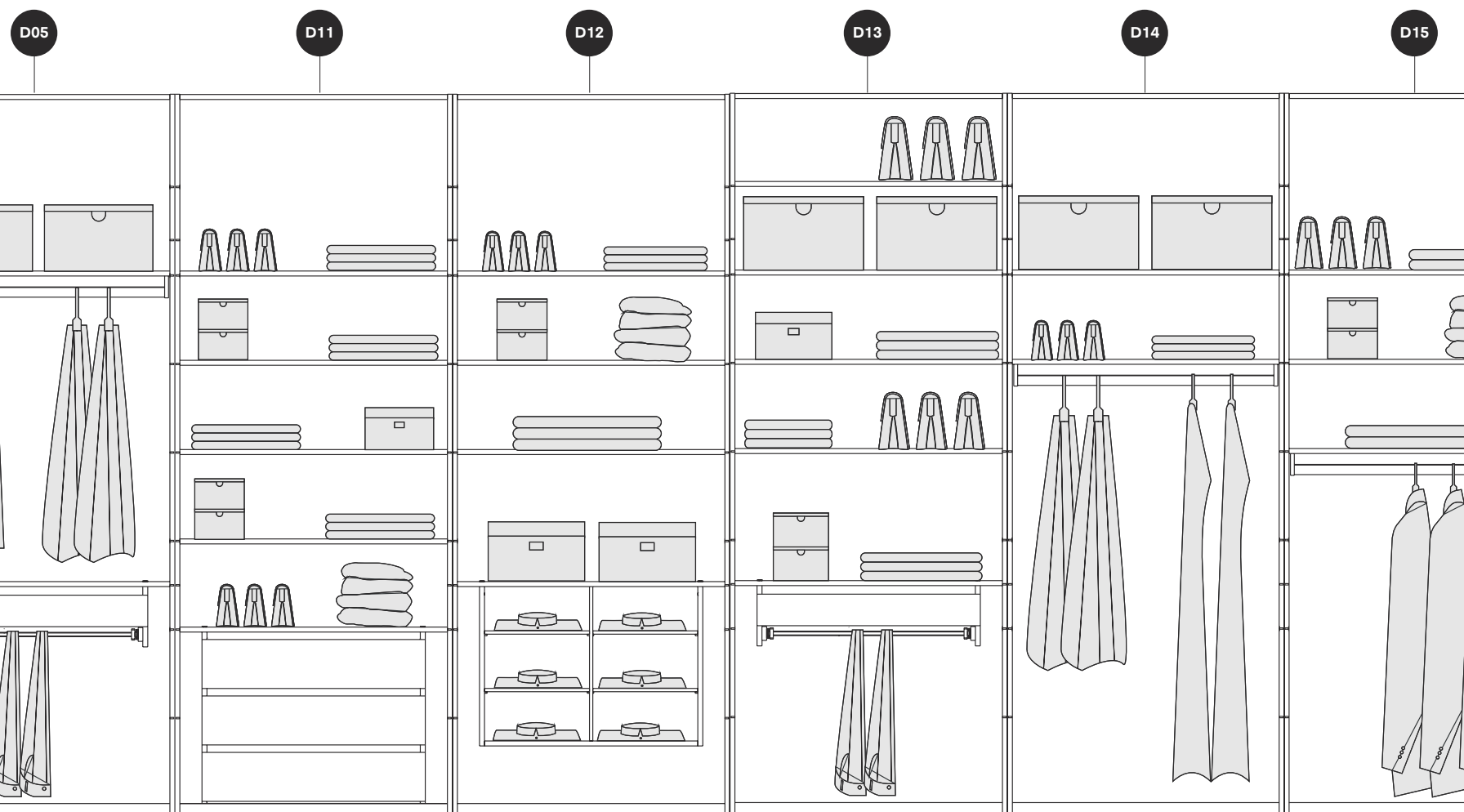

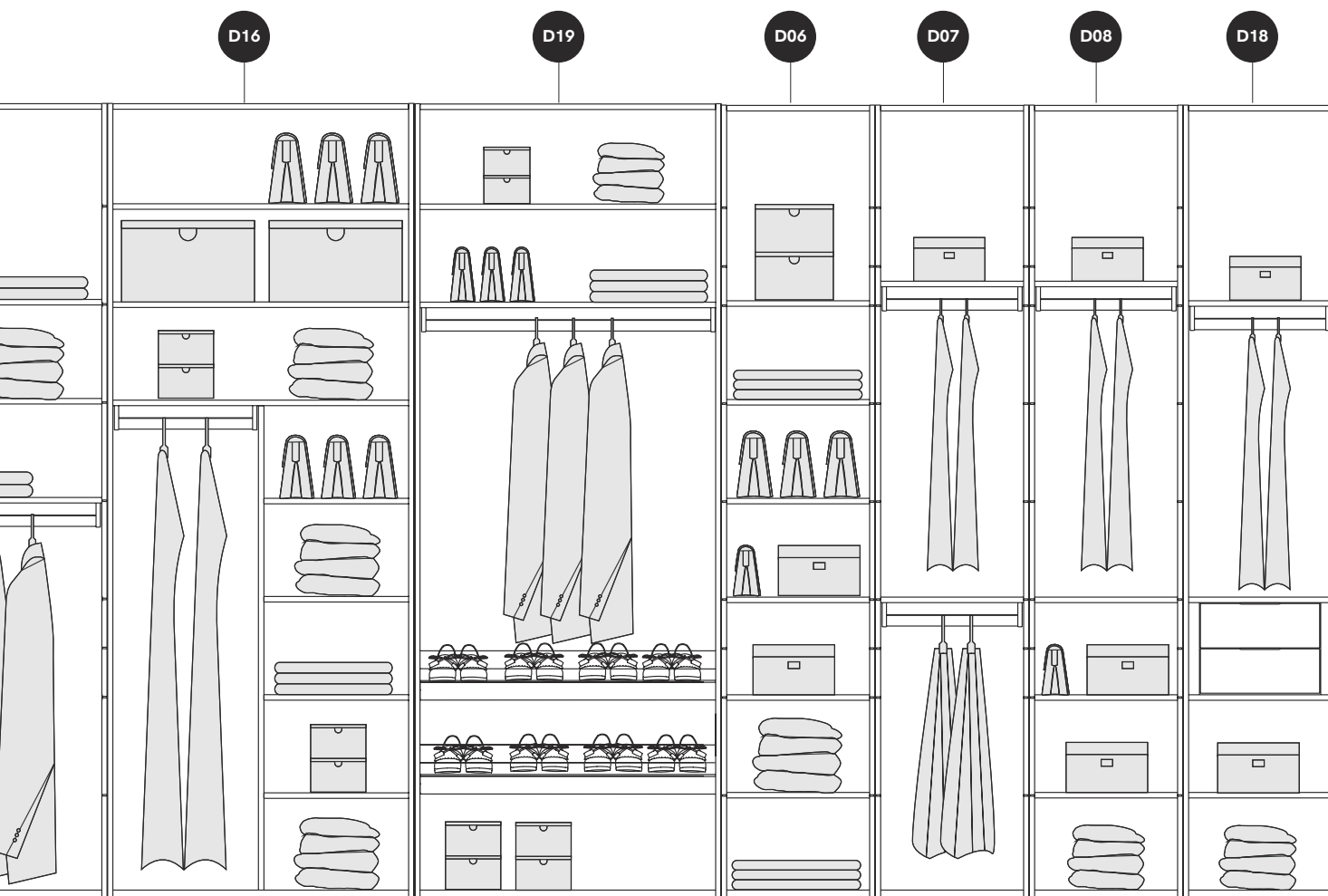

“Bring out the  
designer within you”



# ALFA 260 CM Wardrobe Modules

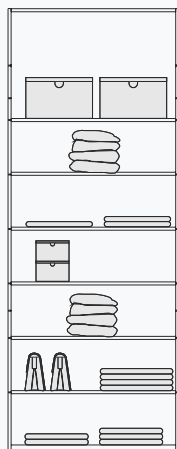

## D 01-260

ALFA  
**DOUBLE  
CABINET  
WITH  
5 SHELVES**

Content of this Order;  
G 02-260 1 pc.  
M 08 2 pcs.  
Consists of these modules.

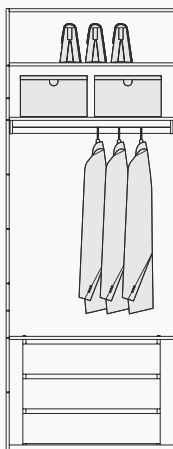

## D 02-260

ALFA  
**DOUBLE  
CABINET  
WITH  
DRAWERS  
MODULE**

Content of this Order;  
G 02-260 1 pc.  
M 01 1 pc.  
M 04 1 pc.  
M 06 1 pc.  
Consists of these modules.

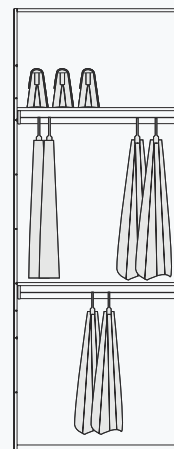

## D 03-260

ALFA  
**DOUBLE  
CABINET  
WITH  
HANGER**

Content of this Order;  
G 02-260 1 pc.  
M 05 1 pc.  
Consists of these modules.

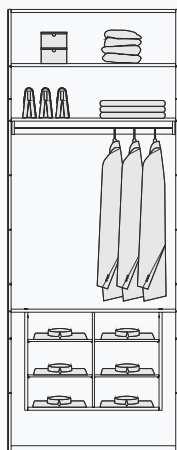

## D 04-260

ALFA  
**DOUBLE  
CABINET  
WITH T-SHIRT  
ORGANIZER**

Content of this Order;  
G 02-260 1 pc.  
M 02 1 pc.  
M 04 1 pc.  
M 06 1 pc.  
Consists of these modules.

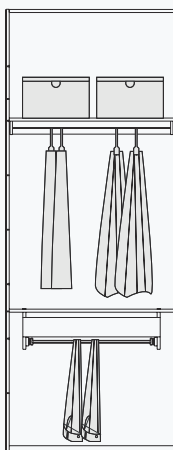

## D 05-260

ALFA  
**DOUBLE  
CABINET  
WITH  
TROUSER  
RACK**

Content of this Order;  
G 02-260 1 pc.  
M 03 1 pc.  
M 04 1 pc.  
Consists of these modules.



## D 06-260

ALFA  
**SINGLE  
CABINET WITH  
5 SHELVES**

Content of this Order;  
G 01-260 1 pc.  
M 13 2 pcs.  
Consists of these modules.

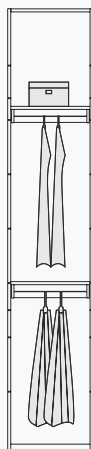

## D 07-260

ALFA  
**SINGLE  
CABINET  
WITH  
HANGER**

Content of this Order;  
G 01-260 1 pc.  
M 10 1 pc.  
Consists of these modules.

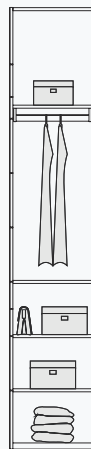

## D 08-260

ALFA  
**SINGLE  
CABINET  
WITH  
3 SHELVES  
AND  
A HANGER**

Content of this Order;  
G 01-260 1 pc.  
M 09 1 pc.  
M 13 1 pc.  
Consists of these modules.



## D 11-260

ALFA  
**DOUBLE  
CABINET  
WITH  
4 SHELVES  
AND  
DRAWERS  
MODULE**

Content of this Order;  
G 02-260 1 pc.  
M 01 1 pc.  
M 07 2 pcs.  
Consists of these modules.



**D 12-260**

ALFA  
**DOUBLE  
CABINET  
WITH T-SHIRT  
ORGANIZER**

Content of this Order;

- G 02-260 1 pc.
- M 02 1 pc.
- M 08 1 pc.

Consists of these modules.



**D 13-260**

ALFA  
**CABINET  
WITH TROUSER  
RACK**

Content of this Order;

- G 02-260 1 pc.
- M 03 1 pc.
- M 07 2 pc.

Consists of these modules.

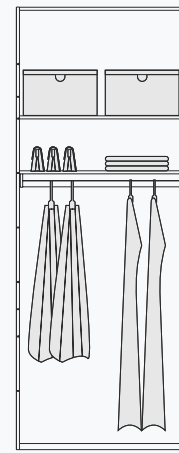

**D 14-260**

ALFA  
**DOUBLE  
CABINET  
WITH  
SINGLE  
SHELF**

Content of this Order;

- G 02-260 1 pc.
- M 04 1 pc.
- M 06 1 pc.

Consists of these modules.

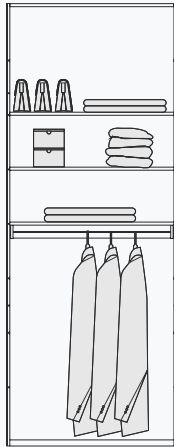

**D 15-260**

ALFA  
**DOUBLE  
CABINET WITH  
A SHELF**

Content of this Order;

- G 02-260 1 pc.
- M 04 1 pc.
- M 07 1 pc.

Consists of these modules.

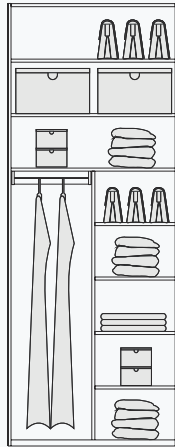

**D 16-260**

ALFA  
**DOUBLE  
CABINET WITH  
SEPARATOR  
MODULE AND  
SHELVES**

Content of this Order;

- G 02-260 1 pc.
- M 14 1 pc.
- M 07 1 pc.

Consists of these modules.

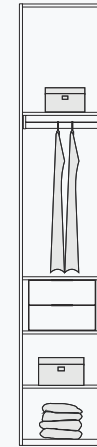

**D 18-260**

ALFA  
**SINGLE  
CABINET  
WITH  
DRAWERS  
MODULE**

Content of this Order;

- G 01-260 1 pc.
- M 16 1 pc.
- M 13 1 pc.
- M 09 1 pc.

Consists of these modules.

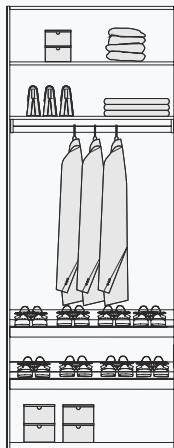

**D 19-260**

ALFA  
**DOUBLE  
CABINET  
WITH SHOES  
ORGANIZER**

Content of this Order;

- G 02-260 1 pc.
- M 20 1 pc.
- M 04 1 pc.
- M 06 1 pc.

Consists of these modules.

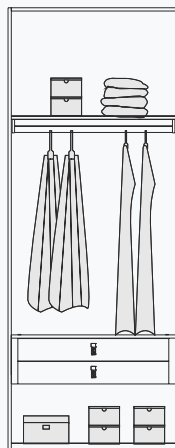

**D 20-260**

ALFA  
**DOUBLE  
CABINET  
WITH TWO DRAWER  
MODULE AND  
HANGER**

Content of this Order;

- G 02-260 1 pc.
- M 04 1 pc.
- M 25 1 pc.

Consists of these modules.



**D 21-260**

ALFA  
**DOUBLE  
CABINET  
WITH TWO DRAWER  
MODULE AND  
SHELVES**

Content of this Order;

- G 02-260 1 pc.
- M 07 2 pc.
- M 25 1 pc.

Consists of these modules.

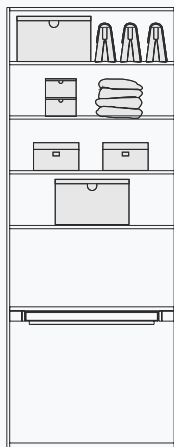

**D 22-260**

**DOUBLE  
CABINET  
WITH LEATHER  
JEWELLERY  
BOX  
AND SHELVES**

Content of this Order;

- G 02-260 1 pc.
- M 26 1 pc.
- M 08 2 pc.

Consists of these modules.

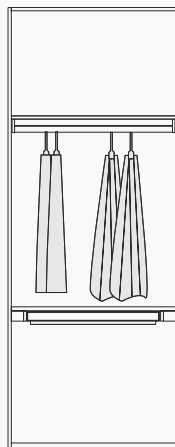

**D 23-260**

ALFA  
**DOUBLE  
CABINET  
WITH LEATHER  
JEWELLERY  
BOX  
AND HANGER**

Content of this Order;

- G 02-260 1 pc.
- M 26 1 pc.
- M 04 1 pc.

Consists of these modules.

# 07

## CHOOSE YOUR COLOR

From warm, classic, modern, simple, and luxurious color tones, which one reflects you the most?

ALFA is designed to perfectly fit your personal style and decoration with its 6 different color options.





**ALFA**  
CLOSURE



**ALFA**  
THICKENING



**G 01**  
**ALFA**  
SINGLE  
CABINET



**G 02**  
**ALFA**  
DOUBLE  
CABINET



**G 03**  
**ALFA**  
CABINET  
WITH SLIDING  
DOORS



**D 09**  
**ALFA**  
CORNER  
CABINET



**D 10**  
**ALFA**  
MIDDLE  
CABINET



ARAL



WHITE



NEVADA

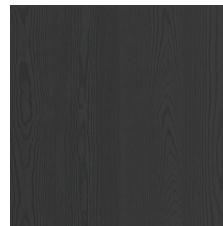

BLACK

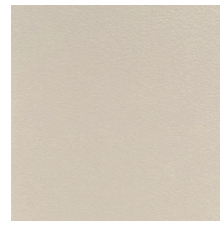

SANDSTONE



OAK



# 08

## SELECT THE CABINET DOORS

Alfa's cabinet door options with freedom of choice make your dressing room stunning. By choosing from 11 different door options, you can customize your wardrobe to complete your room decor. Tinted glass and mirror covers are perfect for those who prefer minimalist design. Framed tinted mirror covers provide a modern and luxurious look. Mdf covers are ideal for those who want to reflect the natural wood appearance in a modern way. Sliding doors save space in your room.



**K 01 / ALFA / LENS DOOR:** Tempered reflective black glass (4mm thickness) with an aluminum frame. The handle is Albi.

**K 02 / ALFA / DOLE DOOR:** Aluminum-framed smoked mirror cover with MDF support at the back for reinforcement. The handle is Albi.

**K 03 / ALFA / LYON DOOR:** Smoked mirror

cover attached to a melamine board. The handle is Piza.

**K 04 / ALFA / REZE DOOR:** 18mm MDF cover with a specially processed painted aluminum frame. The handle is Albi.

**K 05 / ALFA / LAVAL DOOR:** 18mm melamine-

coated board cover. The handle is Laval.

**K 06 / ALFA / PIZA DOOR:** 18mm melamine-coated board cover. The handle is Piza.

**K 07 / ALFA / ALBI DOOR:** 18mm melamine-coated board cover. The handle is Albi.

## Hinged Door Alternatives



**K 01**

**K 02**

**K 03**

**K 04**

**K 05**

**K 06**

**K 07**

**K 12**

**K 13**

**ALFA**  
LENS

**ALFA**  
DOLE

**ALFA**  
LYON

**ALFA**  
REZE

**ALFA**  
LAVAL

**ALFA**  
PIZA

**ALFA**  
ALBI

**ALFA**  
ELIZE

**ALFA**  
DORA

**K 08 / ALFA / LENS SLIDING DOOR:**

A sliding door with an aluminum frame and tempered, reflective black glass.

**K 09 / ALFA / DOLE SLIDING DOOR:**

A sliding door with an aluminum frame and 4 mm smoked mirror. The back of the mirrors are reinforced with MDF.

**K 10 / ALFA / LYON SLIDING DOOR:**

A sliding door with an aluminum handle and an 18 mm melamine board. Half of the door is covered with 4 mm smoked mirror. It comes in 5 different colors.

**K 11 / ALFA / ALBI SLIDING DOOR:** A sliding door with an aluminum handle and an 18 mm melamine board. It comes in 5 different colors.

## Sliding Door Alternatives



**K 08**

**ALFA**  
LENS  
SLIDING  
DOOR



**K 09**

**ALFA**  
DOLE  
SLIDING  
DOOR

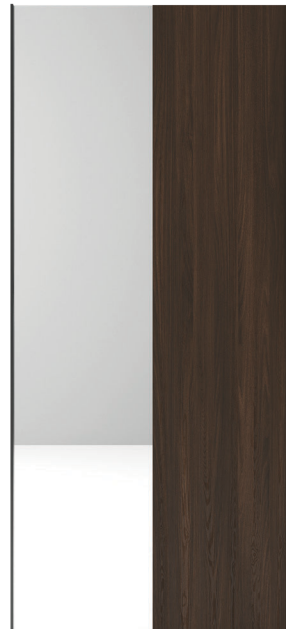

**K 10**

**ALFA**  
LYON  
SLIDING  
DOOR



**K 11**

**ALFA**  
ALBI  
SLIDING  
DOOR

# Alfa cabinet handles are designed to suit different tastes.

With options that provide a modern, natural and warm look, they complement the design and usage of your cabinets according to their sizes and shapes. Additionally, each handle option is meticulously crafted with long-lasting special workmanship to enhance the elegance of your cabinets for a long period of time.

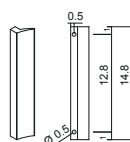
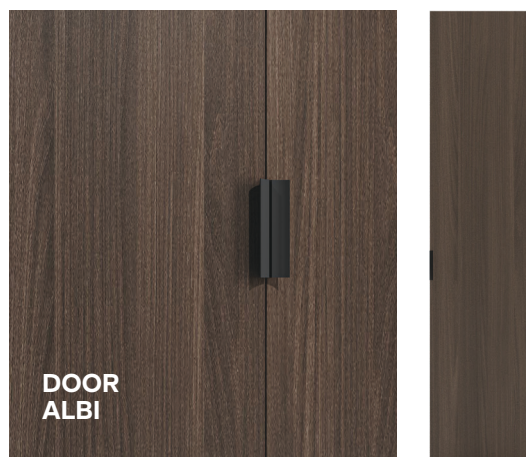

ALBI HANDLE



PIZA HANDLE

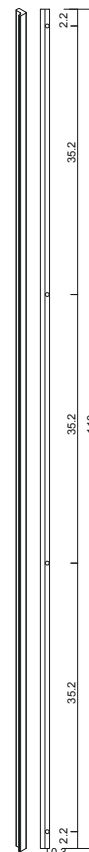
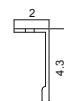

LAVAL HANDLE



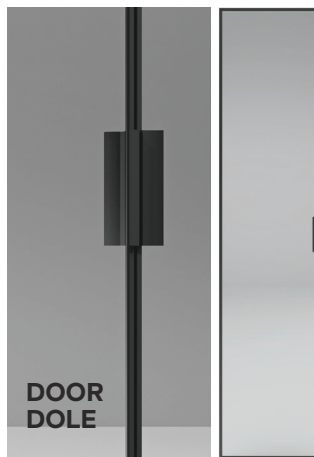
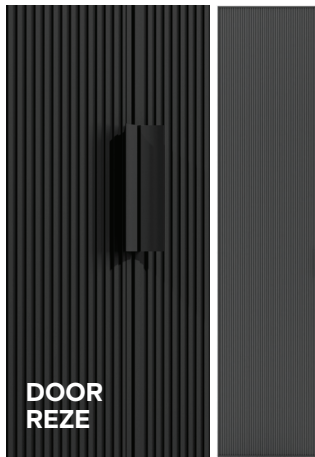
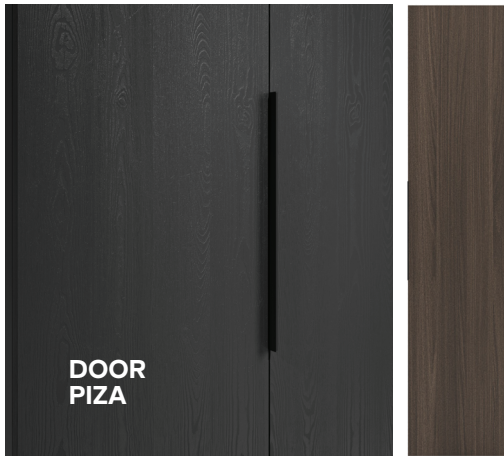

\*Cabinet door is a full-length handle.

\*Cabinet door is a full-length handle.

# 09

## SELECT EXTRA MODULES

ISLANDS

MAKEUP UNIT

MAKEUP TABLE

CABINET SIDE PANEL EXTENSION

TOP MODULE

THICKENING

TV UNIT MODULE





# CABINET SIDE PANEL EXTENSION

If you want your wardrobe to have a more sturdy and sophisticated appearance, this extension is just for you!



Side Panel Extensions do not apply to Cabinets with a height of 210 cm.



Side Panel Extensions do not apply to Cabinets with Sliding doors.



# THICKENING

The thickening alternative combines aesthetics and functionality for a more elegant look. This design detail gives your cabinet an elegant frame effect, while at the same time increasing structural durability and offering long-lasting use.



# MAKEUP MODULES

ALFA offers specially designed makeup modules to make women's makeup routines more enjoyable by considering all the areas they need.

The makeup modules, available in 5 different color options, help women organize their beauty routines and meet their storage needs. Makeup modules include elements such as drawers, shelves, and mirrors, allowing for customizable additions and removals.



 Top Module can be done either with Wooden or aluminum Framed Tempered glass doors.

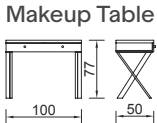
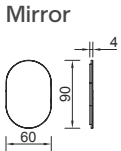
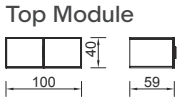
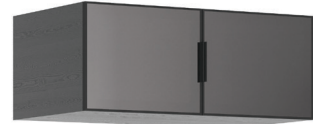

Makeup Unit

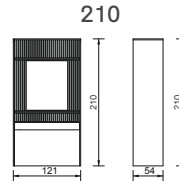
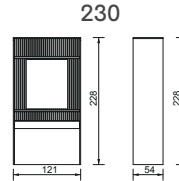
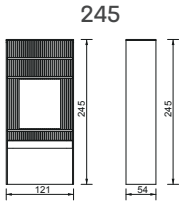
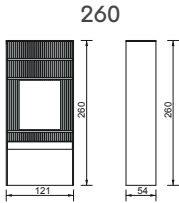



MAKEUP  
UNIT

MAKEUP TABLE



ALFA  
POUF



ALFA  
CHAIR

# ISLANDS

Offered in 5 different color options to complement your wardrobe style. Each island comes with drawers and compartments to help you easily organize your accessories. The durable structure, high-quality materials, and stylish design of our islands make them ideal for adding elegance and functionality to any dressing room.

Our islands' durable construction, high-quality materials, and sleek design make them ideal for adding elegance and functionality to any dressing room.



Island (Big)

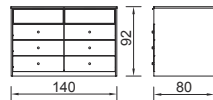

- 16 drawers
- Self-closing tandem rails
- Top panel and drawer fronts with aluminum frames and tempered glass
- Special compartments for your jewelry and accessories
- Velvet-lined drawer bottoms



Island (Small)

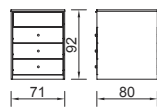

- 8 drawers
- Self-closing tandem rails
- Top panel and drawer fronts with aluminum frames and tempered glass
- Special compartments for your jewelry and accessories
- Velvet-lined drawer bottoms



ARAL



WHITE



NEVADA



BLACK



OAK

# TV UNIT MODULE

Bring comfort and style together with the TV unit module that fits perfectly into your dressing room. Thanks to its design that integrates with your wardrobes, it offers an organised and aesthetic look in your bedroom, while bringing the pleasure of films and TV series to your room. Offering both storage space and a stylish viewing experience with its LED illuminated details and functional drawers, this module is designed to adapt to modern living spaces.

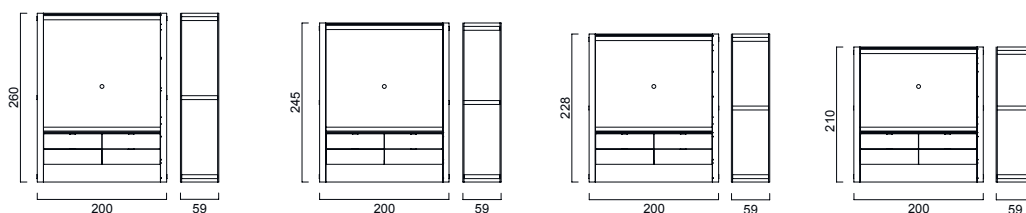

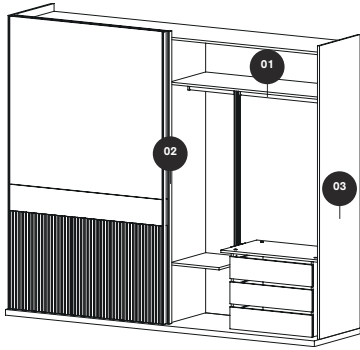

»01

### HANGER

Using elastomer in our hangers prevents them from scratching and making noises.

»02

### PROFILE

2mm Aluminum profiles with inox coating resists color change, bending and scratching.

»03

### CABINET

As our Cabinets are delivered in disassembled conditions it is very important to implant Rafx and Minifix Assembly solutions to make the process simplified and at the same time make sure that finished product is solid to last for a long period of time.

---

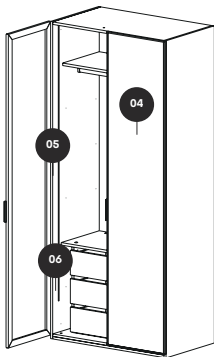

»04

### TEMPERED GLASS

5 times more durable than an ordinary glass. When broken falls into small pieces to prevent serious injuries.

»05

### LED

Homogeneous distribution of light throughout our wardrobes are managed by the control cards. UL Certified.

»06

### HINGES

Soft closing hinges from HAFELE installed on the cabinet doors with dowels. 5 pieces of hinge holding each door to handle the weight and provide smooth operation.

---

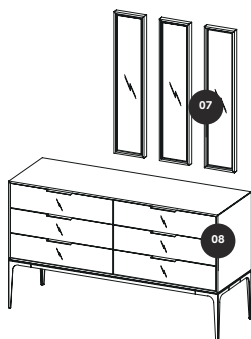

»07

### PAINTING

Polyurethane-based paints with high physical and chemical resistance provides great UV resistance.

»08

### RAILS

German manufactured, Self-retracting, full extension telescopic Hettich Rails with ISO certification.

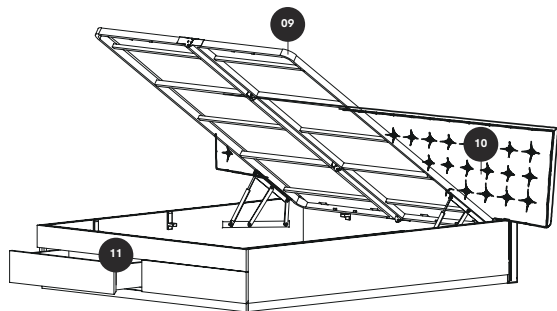

»» 09

### BED BASE

Foldable plinth system being compact and stable at the same time. Locked pistons providing power of 1200 Newtons installed with steel dowels. Unified base with approximately 1m<sup>3</sup> of storage.

»» 10

### FABRICS

High grade polyester fabrics for long lasting and easy maintenance.

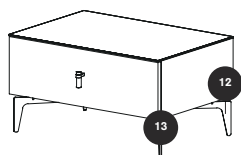

»» 11

### ELECTROSTATIC PAINTING

Solvent-free, Healthy electrostatic oven paint.

»» 12

### METAL LEGS

Laser cut of a 10mm steel plate. Painted with electrostatic oven procedures. Attached.



**saloni**  
art of furniture



## TÜRKİYE CENTER

Yeniceköy Mahallesi  
Fatih Sultan Mehmedhan Bulvarı  
No. 36/1  
İnegöl /Bursa / TÜRKİYE

Phone +90 224 711 31 30

info@saloni.com.tr

saloni.furniture

**444 75 64**

